

Fundamental Analysis

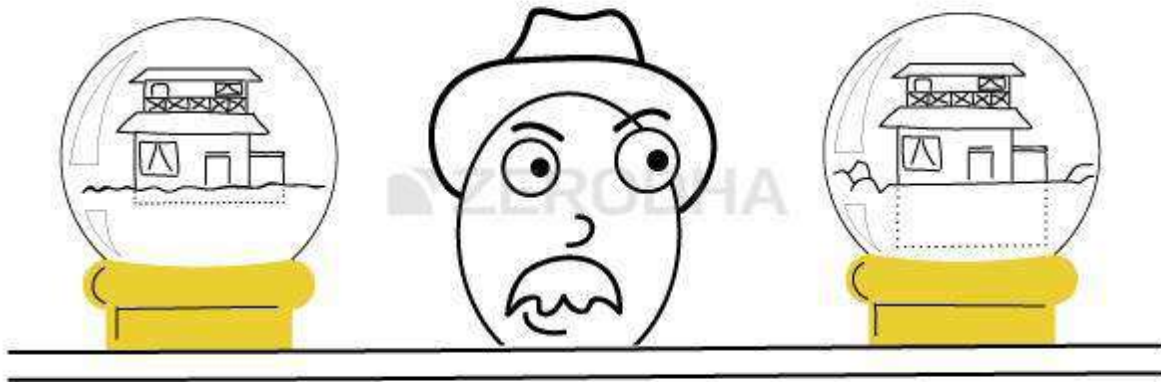

Introduction to Fundamental Analysis



1.1 – Overview

Fundamental Analysis (FA) is a holistic approach to study a business. When an investor wishes to invest in a business for the long term (say 3 – 5 years) it becomes extremely essential to understand the business from various perspectives. It is critical for an investor to separate the daily short term noise in the stock prices and concentrate on the underlying business performance. Over the long term, the stock prices of a fundamentally strong company tend to appreciate, thereby creating wealth for its investors.

We have many such examples in the Indian market. To name a few, one can think of companies such as Infosys Limited, TCS Limited, Page Industries, Eicher Motors, Bosch India, Nestle India, TTK Prestige etc. Each of these companies have delivered on an average over 20% compounded annual growth return (CAGR) year on year for over 10 years. To give you a perspective, at a 20% CAGR the investor would double his money in roughly about 3.5 years. Higher the CAGR faster is the wealth creation process. Some companies such as Bosch India Limited have delivered close to 30% CAGR. Therefore, you can imagine the magnitude, and the speed at which wealth is created if one would invest in fundamentally strong companies.

Here are long term charts of Bosch India, Eicher Motors, and TCS Limited that can set you thinking about long term wealth creation. Do remember these are just 3 examples amongst the many that you may find in Indian markets.



At this point you may be of the opinion that I am biased as I am selectively posting charts that look impressive. You may wonder how the long term charts of companies such as Suzlon Energy, Reliance Power, and Sterling Biotech may look? Well here are the long term charts of these companies:



These are just 3 examples of the wealth destructors amongst the many you may find in the Indian Markets.

The trick has always been to separate the investment grade companies which create wealth from the companies that destroy wealth. All investment grade companies

have a few common attributes that sets them apart. Likewise all wealth destructors have a few common traits which is clearly visible to an astute investor.

Fundamental Analysis is the technique that gives you the conviction to invest for a long term by helping you identify these attributes of wealth creating companies.

1.2 – Can I be a fundamental analyst?

Of course you can be. It is a common misconception that only chartered accountants and professionals from a commerce background can be good fundamental analysts. This is not true at all. A fundamental analyst just adds 2 and 2 to ensure it sums up to 4. To become a fundamental analyst you will need few basic skills:

1. Understanding the basic financial statements
2. Understand businesses with respect to the industry in which it operates
3. Basic arithmetic operations such as addition, subtraction, division, and multiplication

The objective of this module on Fundamental Analysis is to ensure that you gain the first two skill sets.

1.3 – I’m happy with Technical Analysis, so why bother about Fundamental Analysis?

Technical Analysis (TA) helps you garner quick short term returns. It helps you time the market for a better entry and exit. However TA is not an effective approach to create wealth. Wealth is created only by making intelligent long term investments. However, both TA & FA must coexist in your market strategy. To give you a perspective, let me reproduce the chart of Eicher Motors:



Let us say a market participant identifies Eicher motors as a fundamentally strong stock to invest, and therefore invests his money in the stock in the year 2006. As you can see the stock made a relatively negligible move between 2006 and 2010. The real move in Eicher Motors started only from 2010. This also means FA based investment in Eicher Motors did not give the investor any meaningful return between 2006 and 2010. The market participant would have been better off taking short term trades during this time. Technical Analysis helps the investor in taking short term trading bets. Hence both TA & FA should coexist as a part of your market strategy. In fact, this leads us to an important capital allocation strategy called “The Core Satellite Strategy”.

Let us say, a market participant has a corpus of Rs.500,000/-. This corpus can be split into two unequal portions, for example the split can be 60 – 40. The 60% of capital which is Rs.300,000/- can be invested for a long term period in fundamentally strong companies. This 60% of the investment makes up the core of the portfolio. One can expect the core portfolio to grow at a rate of at least 12% to 15% CAGR year on year basis.

The balance 40% of the amount, which is Rs.200,000/- can be utilized for active short term trading using Technical Analysis technique on equity, futures, and options. The Satellite portfolio can be expected to yield at least 10% to 12% absolute return on a yearly basis.



1.4 – Tools of FA

The tools required for fundamental analysis are extremely basic, most of which are available for free. Specifically you would need the following:

1. Annual report of the company – All the information that you need for FA is available in the annual report. You can download the annual report from the company's website for free

2. Industry related data – You will need industry data to see how the company under consideration is performing with respect to the industry. Basic data is available for free, and is usually published in the industry's association website
3. Access to news – Daily News helps you stay updated on latest developments happening both in the industry and the company you are interested in. A good business news paper or services such as Google Alert can help you stay abreast of the latest news
4. MS Excel – Although not free, MS Excel can be extremely helpful in fundamental calculations

With just these four tools, one can develop fundamental analysis that can rival institutional research. You can believe me when I say that you don't need any other tool to do good fundamental research. In fact even at the institutional level the objective is to keep the research simple and logical.

Key takeaways from this chapter

1. Fundamental Analysis is used to make long term investments
2. Investment in a company with good fundamentals creates wealth
3. Using Fundamental Analysis one can separate out an investment grade company from a junk company
4. All investment grade companies exhibit few common traits. Likewise all junk companies exhibit common traits
5. Fundamental analysis helps the analysts identify these traits
6. Both Technical analysis and fundamental analysis should coexist as a part of your market strategy
7. To become a fundamental analyst, one does not require any special skill. Common sense, basic mathematics, and a bit of business sense is all that is required
8. A core satellite approach to the capital allocation is a prudent market strategy
9. The tools required for FA are generally very basic, most of these tools are available for free.

Mindset of an Investor

2.1- Speculator Vs Trader Vs Investor

Depending on how you would like to participate in the market, you can choose to speculate, trade or invest. All the three types of participation are different from one another. One has to take a stance on the type of market participant he would like to be. Having clarity on this can have a huge impact on his Profit & Loss account.



To help you get this clarity, let us consider a market scenario and identify how each one of the market participants (speculator, trader, and investor) would react to it.

SCENARIO

RBI in the next two days is expected to convene to announce their latest stance on the monetary policy. Owing to the high and sticky inflation, RBI has hiked the interest rates during the previous 4 monetary policy reviews. Increase in interest rates, as we know means tougher growth prospects for Corporate India – hence corporate earnings would take a hit.

Assume there are three market participants – Sunil, Tarun, and Girish. Each of them view the above scenario differently, and hence would take different actions in the market. Let us go through their thought process.

(Please note: I will briefly speak about option contracts here, this is only for illustration purpose. We will understand more about derivatives in the subsequent modules)



Sunil: He thinks through the situation and his thought process is as follows:

- He feels the interest rate are at an unsustainably high level
- High interest rates hampers the growth of corporate India
- He also believes that RBI has hiked the interest rates to a record high level and it would be really tough for RBI to hike the rate again
- He looks at what the popular analysts on TV are opinionating about the situation, and he is happy to note that his thoughts and the analyst thoughts are similar
- He concludes that RBI is likely to cut the rates if not for keeping the interest rates flat
- As an outcome, he expects the market to go up

To put his thoughts into action, he buys call options of State Bank of India.



Tarun: He has a slightly different opinion about the situation. His thought process is as below:

- He feels expecting RBI to cut the rates is wishful thinking. In fact he is of the opinion that nobody can clearly predict what RBI is likely to do
- He also identifies that the volatility in the markets is high, hence he believes that option contracts are trading at very high premiums
- He knows from his previous experience (via back testing) that the volatility is likely to drop drastically just after RBI makes its announcement

To put his thoughts into action, he sells 5 lots of Nifty Call options and expects to square off the position just around the announcement time.



Girish: He has a portfolio of 12 stocks which he has been holding for over 2 years. Though he is a keen observer of the economy, he has no view on what RBI is likely to do. He is also not worried about the outcome of the policy as he anyway plans to hold on to his shares for a long period of time. Hence with this perspective he feels the monetary policy is yet another short term passing tide in the market and will not have a major impact on his portfolio. Even if it does, he has both the time and patience to hold on to his shares.

However, Girish plans to buy more of his portfolio shares if the market overreacts to the RBI news and his portfolio stocks falls steeply after the announcement is made.

Now, what RBI will eventually decide and who makes money is not our concern. The point is to identify who is a speculator, a trader, and an investor based on their thought process. All the three men seem to have logic based on which they have taken a market action. Please note, Girish's decision to do nothing itself is a market action.

Sunil seems to be highly certain on what RBI is likely to do and therefore his market actions are oriented towards a rate cut. In reality it is quite impossible to call a shot on what RBI (or for that matter any regulator) will do. These are complex matters and not straightforward to analyze. Betting on blind faith, without a rational reasoning backing ones decision is speculation. Sunil seems to have done just that.

Tarun has arrived at what needs to be done based on a plan. If you are familiar with options, he is simply setting up a trade to take advantage of the high options premium. He is clearly not speculating on what RBI is likely to do as it does not matter to him. His view is simple – volatility is high; hence the premiums are attractive for an options seller. He is expecting the volatility to drop just prior to RBI decision.

Is he speculating on the fact that the volatility will drop? Not really, because he seems to have back tested his strategy for similar scenarios in the past. A trader designs all his trades and not just speculates on an outcome.

Girish, the investor on the other hand seems to be least bit worked up on what RBI is expected to do. He sees this as a short term market noise which may not have any major impact on his portfolio. Even if it did have an impact, he is of the opinion that his portfolio will eventually recover from it. Time is the only luxury markets offer, and Girish is keen on leveraging this luxury to the maximum. In fact he is even prepared to buy more of his portfolio stocks in case the market overreacts. His idea is to hold on to his positions for a long period of time and not get swayed by short term market movements.

All the three of them have different mindsets which leads them to react differently to the same situation. The focus of this chapter is to understand why Girish, the investor has a long term perspective and not really bothered about short term movements in the market.

2.2 – The compounding effect

To appreciate why Girish decided to stay invested and not really react to short term market movement, one has to understand how money compounds. Compounding in simple terms is the ability of money to grow when the gains of year 1 is reinvested for year 2.

For example consider you invest Rs.100 which is expected to grow at 20% year on year (recall this is also called the CAGR). At the end of the first year the money is expected to grow to Rs.120. At the end of year 1 you have two options:

1. Let Rs.20 in profits remain invested along with the original principal of Rs.100 or
2. Withdraw the profits of Rs.20.

You decide not to withdraw Rs.20 profit; instead you decide to reinvest the money for the 2nd year. At the end of 2nd year, Rs.120 grows to Rs.144. At the end of 3rd year Rs.144 grows to Rs.173. So on and so forth.

Compare this with withdrawing Rs.20 profits every year. Had you opted to withdraw Rs.20 every year then at the end of 3rd year the profits would have been just Rs. 60.

However since you decided to stay invested, the profits at the end of 3 years is Rs.173. A good Rs.13 or 21.7% over Rs.60 is generated just because you opted to do nothing and decided to stay invested. This is called the compounding effect. Let us take this analysis a little further, have a look at the chart below:

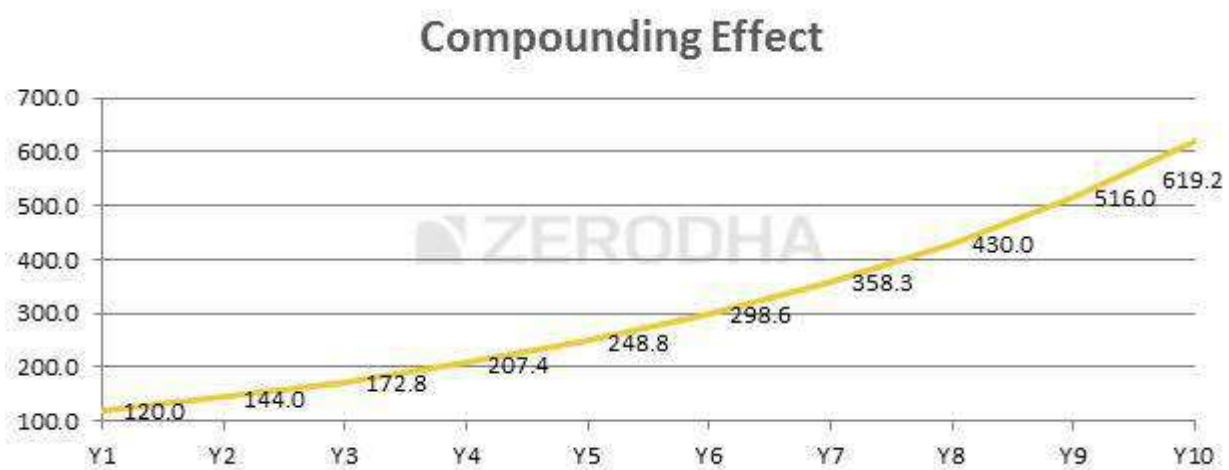

The chart above shows how Rs.100 invested at 20% grows over a 10 year period. If you notice, it took almost 6 years for the money to grow from Rs.100 to Rs.300. However the next Rs.300 was generated in only 4 years i.e from the 6th to 10th year.

This is in fact the most interesting property of the compounding effect. The longer you stay invested, the harder (and faster) the money works for you. This is exactly why Girish decided to stay invested – to exploit the luxury of time that the market offers.

All investments made based on fundamental analysis require the investors to stay committed for the long term. The investor has to develop this mindset while he chooses to invest.

2.3 – Does investing work?

Think about a sapling – if you give it the right amount of water, manure, and care would it not grow? Of course it will. Likewise, think about a good business with healthy sales, great margins, innovative products, and an ethical management. Is it not obvious that the share price of such companies would appreciate? In some situations the price appreciation may delay (recall the Eicher Motors chart from previous chapter), but it certainly will always appreciate. This has happened over and over again across markets in the world, including India.

An investment in a good company defined by **investable grade attributes** will always yield results. However, one has to develop the appetite to digest short term market volatility.

2.4 – Investible grade attributes? What does that mean?

Like we discussed briefly in the previous chapter, an investible grade company has a few distinguishable characteristics. These characteristics can be classified under two heads namely the 'Qualitative aspect' and the 'Quantitative aspects'. The process of evaluating a fundamentally strong company includes a study of both these aspects. In fact in my personal investment practice, I give the qualitative aspects a little more importance over the quantitative aspects.

The Qualitative aspect mainly involves understanding the non numeric aspects of the business. This includes many factors such as:

1. **Management's background** – Who are they, their background, experience, education, do they have the merit to run the business, any criminal cases against the promoters etc
2. **Business ethics** – is the management involved in scams, bribery, unfair business practices
3. **Corporate governance** – Appointment of directors, organization structure, transparency etc
4. **Minority shareholders** – How does the management treat minority shareholders, do they consider their interest while taking corporate actions
5. **Share transactions** – Is the management buying/selling shares of the company through clandestine promoter groups
6. **Related party transactions** – Is the company tendering financial favors to known entities such as promoter's relatives, friends, vendors etc at the cost of the shareholders funds?
7. **Salaries paid to promoters** – Is the management paying themselves a hefty salary, usually a percentage of profits
8. **Operator activity in stocks** – Does the stock price display unusual price behavior especially at a time when the promoter is transacting in the shares

9. **Shareholders** – Who are the significant shareholders in the firm, who are the people with above 1% of the outstanding shares of the company
10. **Political affiliation** – Is the company or its promoters too close to a political party? Does the business require constant political support?
11. **Promoter lifestyle** – Are the promoters too flamboyant and loud about their lifestyle? Do they like to display their wealth?

A red flag is raised when any of the factors mentioned above do not fall in the right place. For example, if a company undertakes too many related party transactions then it would send a signal of favoritism and malpractice by the company. This is not good in the long run. So even if the company has great profit margins, malpractice is not acceptable. It would only be a matter of time before the market discovers matters pertaining to 'related party transactions' and punishes the company by bringing the stock price lower. Hence an investor would be better off not investing in companies with great margins if such a company scores low on corporate governance.

Qualitative aspects are not easy to uncover because these are very subtle matters. However a diligent investor can easily figure this out by paying attention to annual report, management interviews, news reports etc. As we proceed through this module we will highlight various qualitative aspects.

The quantitative aspects are matters related to financial numbers. Some of the quantitative aspects are straightforward while some of them are not. For example cash held in inventory is straight forward however 'inventory number of days' is not. This is a metric that needs to be calculated. The stock markets pay a lot of attention to quantitative aspects. Quantitative aspects include many things, to name few:

1. Profitability and its growth
2. Margins and its growth
3. Earnings and its growth
4. Matters related to expenses
5. Operating efficiency
6. Pricing power
7. Matters related to taxes
8. Dividends payout
9. Cash flow from various activities
10. Debt – both short term and long term
11. Working capital management
12. Asset growth
13. Investments
14. Financial Ratios

The list is virtually endless. In fact, each sector has different metrics. For example:

For a retail Industry:	For an Oil and Gas Industry:
Total number of stores	Oil to Natural Gas revenue ratio
Average sales per store	Exploration costs
Total sales per square foot	Opening oil balance (inventory)
Merchandise margins	Developed reserves
Owned store to franchisee ratio	Total production growth

Over the next few chapters we will understand how to read the basic financial statements, as published in the annual report. As you may know, the financial statement is the source for all the number crunching as required in the analysis of quantitative aspects.

Key takeaways from this chapter:

1. The mindset of a trader and an investor is different
2. The investor has to develop an investment mindset if he is serious about investing
3. The investor should stay invested for a long period of time for the returns to compound
4. The speed at which the money doubles increases drastically the more time you stay invested. This is one of the properties of compounding
5. Every investment has to be evaluated on two aspects – qualitative & quantitative
6. Qualitative aspects revolve around the non numeric information related to the company
7. The quantitative aspects involve analyzing numeric data. The financial statements are the important source of finding the quantitative data.

How to Read the Annual Report of a Company

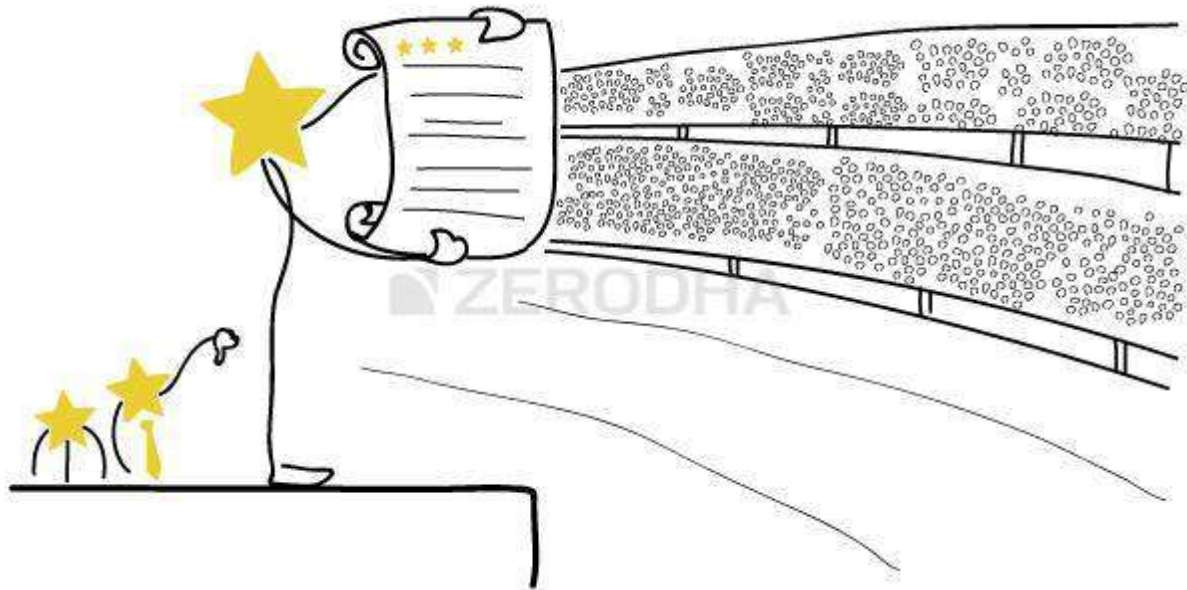

3.1 – What is an Annual Report?

The annual report (AR) is a yearly publication by the company and is sent to the shareholders and other interested parties. The annual report is published by the end of the Financial Year, and all the data made available in the annual report is dated to 31st March. The AR is usually available on the company's website (in the investors section) as a PDF document or one can contact the company to get a hard copy of the same.

Since the annual report is published by the company, whatever is mentioned in the AR is assumed to be official. Hence, any misrepresentation of facts in the annual report can be held against the company. To give you a perspective, AR contains the auditor's certificates (signed, dated, and sealed) certifying the sanctity of the financial data included in the annual report.

Potential investors and the present shareholders are the primary audience for the annual report. Annual reports should provide the most pertinent information to an investor and should also communicate the company's primary message. For an investor, the annual report must be the default option to seek information about a company. Of course there are many media websites claiming to give the financial

information about the company; however the investors should avoid seeking information from such sources. Remember the information is more reliable if we get it directly from the annual report.

Why would the media website misrepresent the company information you may ask? Well, they may not do it deliberately but they may be forced to do it due to other factors. For example the company may like to include 'depreciation' in the expense side of P&L, but the media website may like to include it under a separate header. While this would not impact the overall numbers, it does interrupt the overall sequencing of data.

3.2 – What to look for in an Annual Report?

The annual report has many sections that contain useful information about the company. One has to be careful while going through the annual report as there is a very thin line between the facts presented by the company and the marketing content that the company wants you to read.

Let us briefly go through the various sections of an annual report and understand what the company is trying to communicate in the AR. For the sake of illustration, I have taken the Annual Report of Amara Raja Batteries Limited, belonging to Financial Year 2013-2014. As you may know Amara Raja Batteries Limited manufactures automobile and industrial batteries. You can download ARBL's FY2014 AR from here (http://www.amararaja.co.in/annual_reports.asp)

Please remember, the objective of this chapter is to give you a brief orientation on how to read an annual report. Running through each and every page of an AR is not practical; however, I would like to share some insights into how I would personally read through an AR, and also help you understand what kind of information is required and what information we can ignore.

For a better understanding, I would urge you to download the Annual Report of ARBL and go through it simultaneously as we progress through this chapter.

ARBL's annual report contains the following 9 sections:

- Financial Highlights
- The Management Statement
- Management Discussion & Analysis
- 10 year Financial highlights
- Corporate Information
- Director's Report
- Report on Corporate governance
- Financial Section, and

- Notice

Note, no two annual reports are the same; they are all made to suite the company's requirement keeping in perspective the industry they operate in. However, some of the sections in the annual report are common across annual reports.

The first section in ARBL's AR is the **Financial Highlights**. Financial Highlights contains the bird's eye view on how the financials of the company looks for the year gone by. . The information in this section can be in the form of a table or a graphical display of data. This section of the annual report generally does a multi-year comparison of the operating and business metrics.

Here is the snapshot of the same:



The details that you see in the Financial Highlights section are basically an extract from the company's financial statement. Along with the extracts, the company can also include a few financial ratios, which are calculated by the company itself. I briefly look through this section to get an overall idea, but I do not like to spend too much time on it. The reason for looking at this section briefly is that, I would anyway calculate these and many other ratios myself and while I do so, I would gain greater clarity on the company and its numbers. Needless to say, over the next few chapters we will understand how to read and understand the financial statements of the company and also how to calculate the financial ratios.

The next two sections i.e the '**Management Statement**' and '**Management Discussion & Analysis**' are quite important. I spend time going through these sections. Both these sections gives you a sense on what the management of the company has to say about their business and the industry in general. As an investor or as a potential investor in the company, every word mentioned in these sections is

important. In fact some of the details related to the 'Qualitative aspects' (as discussed in chapter 2), can be found in these two sections of the AR.

In the 'Management Statement' (sometimes called the Chairman's Message), the investor gets a perspective of how the man sitting right on top is thinking about his business. The content here is usually broad based and gives a sense on how the business is positioned. When I read through this section, I look at how realistic the management is. I am very keen to see if the company's management has its feet on the ground. I also observe if they are transparent on discussing details on what went right and what went wrong for the business.

One example that I explicitly remember was reading through the chairman's message of a well established tea manufacturing company. In his message, the chairman was talking about a revenue growth of nearly 10%, however the historical revenue numbers suggested that the company's revenue was growing at a rate of 4-5%. Clearly in this context, the growth rate of 10% seemed like a celestial move. This also indicated to me that the man on top may not really be in sync with ground reality and hence I decided not to invest in the company. Retrospectively when I look back at my decision not to invest, it was probably the right decision.

Here is the snapshot of Amara Raja Batteries Limited; I have highlighted a small part that I think is interesting. I would encourage you to read through the entire message in the Annual Report.



Dear friends,

The Company's product sales are climbing; brands have been a resounding success; factories are buzzing with activity; people are happy and you, the shareholders, are satisfied.

Logic says we should be content. Rationality guides us to make incremental investments. Prudence advises cautious aggression.

At this crucial juncture, we can either be satisfied with the bountiful returns; or undertake the challenge of doing the extraordinary that transforms the perception of the brand and the corporate in the minds of the

whole. Here at Amara Raja, we have opted for the latter option. Case in point: we initiated our largest capacity augmentation exercise at a time when most corporates chose to put their capex investments on the backburner.

Because Amara Raja has relentlessly attempted to outperform the prevailing growth averages. And has inevitably made it happen through a combination of superior product quality, distinctive positioning, attractive price-value proposition, enduring OEM customer relationships, deeper distribution network, prudent fiscal management and a proactive ability to invest ahead of the curve.

The efficacy of this approach is reflected in the superior numbers that Amara Raja posted in 2013-14 – 16.15% increase in revenues, 28.16% in profit after tax, growth in return on capital employed by 78 bps - even as the Indian economy reported its second slowest growth of the last 10 years in 2013-14.

Recharged

Recharged – this single word aptly sums up the energy within Amara Raja's team, which provides assurance that our largest capacity augmentation investment will turn out to be an unprecedented success. For it is not

Moving ahead, the next section is the '**Management Discussion & Analysis**' or 'MD&A'. This according to me is perhaps one of the most important sections in the whole of AR. The most standard way for any company to start this section is by talking about the macro trends in the economy. They discuss the overall economic activity of the country and the business sentiment across the corporate world. If the company has high exposure to exports, they even talk about global economic and business sentiment.

ARBL has both exports and domestic business interest; hence they discuss both these angles in their AR. See the snapshot below:



Global economy

The global economy remain subdued as global GDP growth decelerated for the third year – 3.9% in 2011 to 3.1% in 2012 and 3% in 2013. Most developed economies addressed the reality through appropriate remedial fiscal policy action. Besides, a number of emerging economies, which had already experienced a debilitating slowdown in the past two years, encountered new domestic and international headwinds during this period.

Prospects: Looking ahead, global growth is projected to strengthen to 3.6% in 2014 and 3.9% in 2015 (Source: IMF April 2014). Global activity is expected to improve during 2014-15, with much of the impetus coming from advanced economies. Many emerging market economies account for more than two-thirds of global growth and their output growth is likely to be lifted by exports to advanced economies.

Challenge: Global recovery is still fragile despite improved prospects with significant downside risks. Among old risks, those related to emerging market economies increased. According to the Global Financial Stability Report, rapid normalisation of the American monetary policy or renewed bouts of high risk aversion on the part of investors could result in further pain (Source: IMF, April 2014).

ARBL's view on the Indian economy:

Indian economy

India's economic growth of 4.7% in 2013-14 was marginally higher than the previous year due to an improved performance in the agriculture and allied sectors.

The slowdown was primarily due to an unsupportive external environment, regulatory policy logjam, structural constraints and inflation. Despite these challenges, there were positives which provided a foundation for resurgence:

The current account deficit contracted; the fiscal deficit target was met

India implemented substantive measures to narrow external and fiscal imbalances, tighten monetary policy, move forward on structural reforms and address market volatility to reduce vulnerability

India built upon its foreign exchange reserves

The Indian economy is placed better than what it was in 2013. A dynamic government at the Centre strengthens optimism of robust economic growth, which is projected at 5.6% in 2014, rising to 6.0% in 2015 (Source: RBI).

User sectors

Telecom: India's telecom industry posted a 10.1% revenue growth in 2013-14 from 8.6% in the previous fiscal despite intense competition and call rates declining to an all-time low. The improvement was largely a result of growth in the wireless subscriber base, reduced churn levels and an improvement in revenue realisation.

More importantly, 2013-14 will be regarded as a transformational year for the industry. The uncertainty of the previous years ended with fresh spectrum auctions taking place. The Department of Telecom, Government of India, announced significant initiatives - revision of the 'tower rollout policy' and the 'mergers and acquisitions

Chilling plant cooling towers
New plant at
Hunegundepalle
village



Following this the companies usually talk about the trends in the industry and what they expect for the year ahead. This is an important section as we can understand what the company perceives as threats and opportunities in the industry. Most importantly I read through this, and also compare it with its peers to understand if the company has any advantage over its peers.

For example, if Amara Raja Batteries limited is a company of interest to me, I would read through this part of the AR and also would read through what Exide Batteries Limited has to say in their AR.

Remember until this point the discussion in the Management Discussion & Analysis is broad based and generic (global economy, domestic economy, and industry trends). However going forward, the company would discuss various aspects related to its business. It talks about how the business had performed across various divisions, how did it fare in comparison to the previous year etc. The company in fact gives out specific numbers in this section.

Here is a snapshot of the same:

Overview	Products	Distribution network	Customers	Niche features
<p>Commenced operations in 2000 with technology from Johnson Controls Inc. USA</p> <p>Manufacturing facility is QS-9000, ISO-14001 and TS- 16949 certified</p>	<p>Passenger cars: Amaron® Pro, Amaron® Flo, Amaron® Go, Amaron® Black and Amaron® Fresh</p> <p>Commercial vehicles: Amaron® Hiway</p> <p>Tractors: Amaron® Harvest</p> <p>Two-wheelers: Amaron Pro Bike Rider™</p>	<p>Amaron® network comprises 294 franchised distributors, including 25,000-plus retailers</p> <p>PowerZone™ network comprises 1,100 retail outlets ensuring widespread semi-urban and rural presence</p>	<p>Major OEM customers: Ford, Maruti Suzuki, Hyundai, Honda, M&M, Tata, Volvo, Eicher, Daimler Benz, TAFE Tractors, Isuzu Motors among others</p> <p>Major private label customers: Bosch, Lucas, Cummins and AC Delco</p> <p>Leading player in the aftermarket segment among four-wheelers</p>	<p>Battery supplier to the entire 'Comfort Delgro' taxi fleet in Singapore.</p> <p>100% share of business with Ford India and Daimler Benz</p> <p>100% share of business in Maruti A-Star exports and Hyundai EON</p> <p>First supplier of batteries to Mahindra and Mahindra for Scorpio micro hybrid vehicles</p> <p>First to introduce zero maintenance four-wheeler batteries and VRLA two-wheeler batteries</p> <p>First to provide extended warranties to consumers</p>

Some companies even discuss their guidelines and strategies for the year ahead across the various verticals they operate in. Do have a look at the snapshot below:

Rising rural income: The government shifted its focus towards rural sector development. The government's crop price support policy over the last five years has led to higher rural incomes.

Aftermarket
Every vehicle added on Indian roads creates an aftermarket opportunity as batteries need to be changed every few years. So while OE demand extends only to assembly, the aftermarket demand stays robust across useful asset life, making the aftermarket a significantly larger opportunity. And while the OE market may experience volatility consequent to economic and business

cycles, the aftermarket growth rate remains relatively stable.
Since the battery is a critical component in every automobile (including a two-wheeler), long life and reliability are the most important factors influencing purchase. With the organised sector providing a superior value-proposition, there is an increasing shift towards branded batteries in the aftermarket segment.

Amara Raja's strategy
Aftermarket: The Company's significant presence in the aftermarket segment deters it from sectoral cyclicality. Going forward, the Company will continue to

strengthen its distribution network by entering areas where its penetration is low, filling gaps in its product range and ensuring supply chain efficiency. Moreover, the Company will continue to invest in brand promotion and ground-level initiatives to develop a stronger bond with customers, retailers and distributors.

OE market: While the aftermarket is the key revenue earner, the Company is also working to forge stronger relationships with leading and reputed OE players in the automotive market, which will increase its brand preference at the time of replacement.

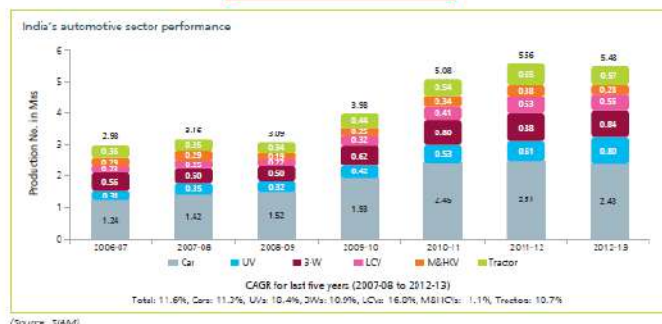

After discussing these in 'Management Discussion & Analysis' the annual report includes a series of other reports such as – Human Resources report, R&D report, Technology report etc. Each of these reports are important in the context of the

industry the company operates in. For example, if I am reading through a manufacturing company annual report, I would be particularly interested in the human resources report to understand if the company has any labor issues. If there are serious signs of labor issues then it could potentially lead to the factory being shut down, which is not good for the company's shareholders.

3.3 – The Financial Statements

Finally, the last section of the AR contains the financial statements of the company. As you would agree, the financial statements are perhaps one of the most important aspects of an Annual Report. There are three financial statements that the company will present namely:

1. The Profit and Loss statement
2. The Balance Sheet and
3. The Cash flow statement

We will understand each of these statements in detail over the next few chapters. However at this stage it is important to understand that the financial statements come in two forms.

1. Standalone financial statement or simply standalone numbers and
2. Consolidated financial statement or simply consolidated numbers

To understand the difference between standalone and consolidated numbers, we need to understand the structure of a company.

Typically, a well established company has many subsidiaries. These companies also act as a holding company for several other well established companies. To help you understand this better, I have taken the example of CRISIL Limited's shareholding structure. You can find the same in CRISIL's annual report. As you may know, CRISIL is an Indian company with a major focus on corporate credit rating services.

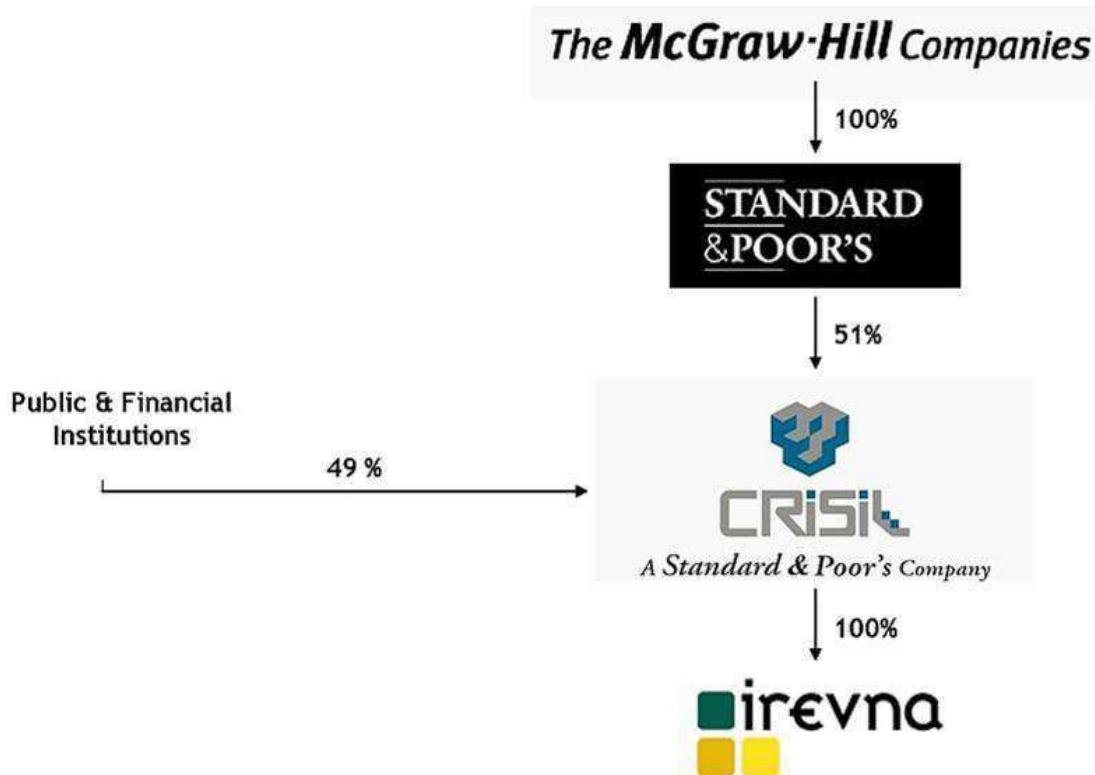

As you can see in the above share holding structure:

1. Standard & Poor's (S&P), a US based rating agency holds a 51% stake in CRISIL. Hence S&P is the 'Holding company' or the 'Promoter' of CRISIL
2. The balance 49% of shares of CRISIL is held by Public and other Financial institutions
3. However, S&P itself is 100% subsidiary of another company called 'The McGraw-Hill Companies'
1. This means McGraw Hill fully owns S&P, and S&P owns 51% of CRISIL
4. Further, CRISIL itself fully owns (100% shareholding) another company called 'Irevna'.

Keeping the above in perspective, think about this hypothetical situation. Assume, for the financial year 2014, CRISIL makes a loss of Rs.1000 Crs and Irevna, its 100% subsidiary makes a profit of Rs.700 Crs. What do you would be the overall profitability of CRISIL?

Well, this is quite simple – CRISIL on its own made a loss of Rs.1000 Crs, but its subsidiary Irevna made a profit of Rs.700 Crs, hence the overall P&L of CRISIL is (Rs.1000 Crs) + Rs.700 Crs = (Rs.300 Crs).

Thanks to its subsidiary, CRISIL's loss is reduced to Rs.300 Crs as opposed to a massive loss of Rs.1000 Crs. Another way to look at it is, CRISIL on a **standalone** basis made a loss of Rs.1000 Crs, but on a **consolidated** basis made a loss of Rs.300 Crs.

Hence, Standalone Financial statements represent the standalone numbers/ financials of the company itself and do not include the financials of its subsidiaries. However the consolidated numbers includes the companies (i.e.standalone financials) and its subsidiaries financial statements.

I personally prefer to look through the consolidated financial statements as it gives a better representation of the company's financial position.

3.4 – Schedules of Financial Statements

When the company reports its financial statements, they usually report the full statement in the beginning and then follow it up with a detailed explanation.

Have a look at the snapshot of one of ARBL's financial statement (balance sheet):

Particulars	Note No.	As at March 31, 2014	As at March 31, 2013
EQUITY AND LIABILITIES			
Shareholders' funds			
Share capital	2	170.81	170.81
Reserves and surplus	3	13,456.20	10,427.33
		13,627.01	10,598.14
Non-current liabilities			
Long-term borrowings	4	759.47	773.13
Deferred tax liabilities (net)	5	301.33	195.09
Long-term provisions	6	369.57	376.41
		1,430.37	1,344.63
Current liabilities			
Short-term borrowings	7	83.83	98.63
Trade payables	8	1,277.79	1,362.84
Other current liabilities	9	2,156.68	1,807.26
Short-term provisions	6	2,818.73	2,493.20
		6,337.03	5,761.93
Total		21,394.41	17,704.70

Each particular in the financial statement is referred to as the line item. For example the first line item in the Balance Sheet (under Equity and Liability) is the share capital (as pointed out by the green arrow). If you notice, there is a note number associated with share capital. These are called the 'Schedules' related to the financial statement. Looking into the above statement, ARBL states that the share capital stands at Rs.17.081 Crs (or Rs.170.81 Million). As an investor I obviously would be interested to know how ARBL arrived at Rs.17.081 Crs as their share capital. To figure this out, one needs to look into the associated schedule (note number 2). Please look at the snapshot below:

Notes forming part of the Financial Statements

NOTE 2: SHARE CAPITAL

Particulars	₹ million	
	As at March 31, 2014	As at March 31, 2013
Equity share capital		
Authorised		
200,000,000 Equity shares of ₹1 each	200.00	200.00
Issued	-	-
175,028,500 Equity shares of ₹1 each	175.03	175.03
Subscribed and paid up	-	-
170,812,500 Equity shares of ₹1 each	170.81	170.81
Total	170.81	170.81

Of course, considering you may be new to financial statements, jargon's like share capital make not make much sense. However the financial statements are extremely simple to understand, and over the next few chapters you will understand how to read the financial statements and make sense of it. But for now do remember that the main financial statement gives you the summary and the associated schedules give the details pertaining to each line item.

Key takeaways from this chapter

1. The Annual Report (AR) of a company is an official communication from the company to its investors and other stakeholders
2. The AR is the best source to get information about the company; hence AR should be the default choice for the investor to source company related information
3. The AR contains many sections, with each section highlighting certain aspect of the business
4. The AR is also the best source to get information related to the qualitative aspects of the company
5. The management discussion and analysis is one of the most important sections in the AR. It has the management's perspective on the overall economy of the country, their outlook on the industry they operate in for the year gone by (what went right and what went wrong), and what they foresee for the year ahead
6. The AR contains three financial statements – Profit & Loss statement, Balance Sheet, and Cash Flow statement
7. The standalone statement contains the financial numbers of only the company in consideration. However the consolidated numbers contains the company and its subsidiaries financial numbers.

Understanding the P&L Statement (Part 1)

4.1 – Overview of the financial statements

You can think about the financial statements from two different angles:

1. From the maker's perspective
2. From the user's perspective

A maker prepares the financial statements. He is typically a person with an accounting background. His job involves preparing ledger entries, matching bills and receipts, tallying the inflows versus the outflows, auditing etc. The final objective of the is to prepare transparent financial statements which best represents the true financial position of the company. To prepare such a financial statement certain skills are required, usually these skills are developed through the rigor of a Chartered Accountant's training program.

The user on the other hand just needs to be in a position to understand what the maker has prepared. He is just the user of the financial statements. He need not really know the details of the journal entries or the audit procedure. His main concern is to read what is being stated and use it to make his decisions.

To put this in context, think about Google. Most of us do not understand Google's complex search engine algorithm that runs in the backend, however we all know how to use Google effectively. Such is the distinction between the maker and the user of financial statements.

A common misconception amongst the market participants is that, they believe the fundamental analyst needs to be thorough with concepts of financial statement preparation. While knowing this certainly helps, it is not really required. To be a fundamental analyst, one just needs to be the user and not the maker of the financial statements.

There are three main financial statements that a company showcases to represent its performance.

1. The Profit and Loss statement
2. The Balance Sheet
3. The Cash flow statement

Over the next few chapters we will understand each of these statements from the user's perspective.

4.2 – The Profit and Loss statement

The Profit and Loss statement is also popularly referred to as the P&L statement, Income Statement, Statement of Operations, and Statement of Earnings. The Profit and Loss statement shows what has transpired during a time period. The P&L statement reports information on:

1. The revenue of the company for the given period (yearly or quarterly)
2. The expenses incurred to generate the revenues
3. Tax and depreciation
4. The earnings per share number

From my experience, the financial statements are best understood by looking at the actual statement and figuring out the information. Hence, here is the P&L statement of Amara Raja Batteries Limited (ARBL). Let us understand each and every line item.

Particulars	Note No.	Year ended March 31, 2014	Year ended March 31, 2013
REVENUE			
Sale of products		38,041.27	32,949.37
Less: Excise duty		4,005.15	3,512.45
Net sale of products		34,036.12	29,436.92
Sale of services		309.32	137.02
Other operating revenue		21.15	15.21
Net revenue from operations	17	34,366.59	29,589.15
Other income	18	455.14	465.51
Total Revenue		34,821.73	30,054.66
EXPENSES			
Cost of materials consumed	19	21,011.95	17,603.12
Purchases of stock-in-trade	20	2,113.69	2,632.54
Changes in inventories of finished goods, work-in-process and stock-in-trade	20	(292.10)	(320.89)
Employee benefits expense	21	1,583.16	1,262.30
Finance costs	22	7.18	2.69
Depreciation and amortisation expense (includes impairment loss of ₹Nil (PY ₹75.52 million))	23	645.71	660.92
Other expenses	24	4,346.60	3,904.24
Total Expenses		29,416.19	25,744.92
Profit before exceptional items and tax		5,405.54	4,309.74
Less: Exceptional items (net)	33	38.84	91.57
Profit before tax		5,366.70	4,218.17
Less: Tax expense			
Current tax		1,580.00	1,377.97
Deferred tax (credit) / expense		106.23	(24.51)
Earlier year's (excess) / short provision		6.11	(2.34)
Profit for the year		3,674.36	2,867.05
Basic and diluted earnings per equity share of ₹1 each	37	21.51	16.78

4.3 – The Top Line of the company (Revenue)

You may have heard analysts talk about the top line of a company. When they do so, they are referring to the revenue side of the P&L statement. The revenue side is the first set of numbers the company presents in the P&L.



Before we start understanding the revenue side, let us notice a few things mentioned on the header of the P&L statement:

Statement of Profit and Loss for the year ended March 31, 2014		₹ million	
Particulars	Note No.	Year ended March 31, 2014	Year ended March 31, 2013

The header clearly states:

1. The statement of P&L for the year **ending** March 31, 2014, hence this is an annual statement and not a quarterly statement. Also, since it is as of March 31st 2014 it is evident that the statement is for the Financial Year 2013 – 2014 or simply it can be referred to as the FY14 numbers
2. All currency is denominated in Rupee Million. Note – 1 Million Rupees is equal to Ten Lakh Rupees. It is upto the company's discretion to decide which unit they would prefer to express their numbers in
3. The particulars show all the main headings of the statement. Any associated note to the particulars is present in the note section (also called the schedule). An associated number is assigned to the note (Note Number)
4. By default when companies report the numbers in the financial statement they present the current year number on the left most column and the previous year number to the right. In this case the numbers are for FY14 (latest) and FY13 (previous)

The first line item on the revenue side is called the **Sale of Products**.

Since we know we are dealing with a batteries company, clearly sale of products means the Rupee value of all the battery sales the company has sold during FY14. The sales stand at Rs.38,041,270,000/- or about Rs.3,804 Crore. The company sold batteries worth Rs.3,294 Cr in the previous financial year i.e FY13.

Please note, I will restate all the numbers in Rupee Crore as I believe this is more intuitive to understand.

The next line item is the excise duty. This is the amount (Rs.400 Crs) the company would pay to the government; hence the revenue has to be adjusted.

The revenue adjusted after the excise duty is the **net sales of the company**. The net sales of ARBL is Rs.3403 Crs for FY14. The same was Rs.2943 Crs for FY13.

Apart from the sale of products, the company also draws revenue from services. This could probably be in the form of annual battery maintenance. The revenue from sale of services stands at Rs.30.9Crs for FY14.

The company also includes “other operating revenues” at Rs.2.1crs.This could be revenues through the sale of products or services that is incidental to the core operations of the company.

Finally the revenue from Sale of products + Sale of services + Other operating revenues sums up to give the **total operating revenue** of the company. This is reported at Rs.3436 Crs for FY14 and Rs.2959Crs for FY13. Interesting, there is a note; numbered 17 associated with “Net Revenue from Operations” which will help us inspect this aspect further.

Do recall, in the previous chapter we had discussed about notes and schedules of the financial statement.

The following snapshot gives the details of note 17.

Notes forming part of the Financial Statements

NOTE 17: REVENUE FROM OPERATIONS

₹ million

Particulars	Year ended March 31, 2014	Year ended March 31, 2013
a) Sale of products		
Storage batteries (finished goods)	35,237.83	30,363.83
Storage batteries (stock-in-trade)	2,089.86	1,493.93
Home UPS (stock-in-trade)	713.58	1,091.61
Gross revenue from sale of products	38,041.27	32,949.37
Less: Excise duty	4,005.15	3,512.45
Net revenue from sale of products	34,036.12	29,436.92
b) Sale of services		
Installation and commissioning	49.14	17.36
Annual maintenance	146.91	96.09
Preventive maintenance	15.41	5.75
Other services	97.86	17.82
Net revenue from sale of services	309.32	137.02
c) Other operating revenue		
Sale of process scrap	21.15	15.21
Net revenue from operations	34,366.59	29,589.15

Clearly, the notes give a more detailed analysis of the split up of **revenues from operations** (does not include other income details). As you can see under the particulars, section 'a' talks about the split up under sales of products.

1. Sale of storage batteries in the form of finished goods for the year FY14 is Rs.3523 Crs versus Rs.3036 Crs in FY13
2. Sale of Storage batteries (stock in trade) is Rs.208 Crs in FY14 versus 149 Crs. Stock in trade refers to finished goods of previous financial year being sold in this financial year
3. Sale of home UPS (stock in goods) is at Rs.71 Crs in FY14 versus Rs.109 Crs FY13
4. Net sales from sales of products adjusted for excise duty amounts to Rs.3403 Crs, which matches with the number reported in the P&L statement
5. Likewise you can notice the split up for revenue from services. The revenue number of Rs.30.9 tallies with number reported in the P&L statement
6. In the note, the company says the "Sale of Process Scrap" generated revenue of Rs.2.1 Cr. Note that the sale of process scrap is incidental to the operations of the company, hence reported as 'Other operating revenue'.
7. Adding up all the revenue streams of the company i.e Rs.3403 Crs+ Rs.30.9 Crs +Rs.2.1 Crs gets us the Net revenue from operations = Rs.3436 Crs.
8. You can also find similar split up for FY13

If you notice the P&L statement, apart from net revenue from operations ARBL also reports 'Other Income' of Rs.45.5 Crs. Note number 18 reproduced below explains what the other income is all about.

NOTE 18: OTHER INCOME

₹ million

Particulars	Year ended March 31, 2014	Year ended March 31, 2013
Interest Income		
On bank and other deposits	131.22	112.29
Against trade receivables	6.72	10.27
Dividend income		
On current investments - mutual funds	142.68	143.96
On long term investments - equity instruments	1.51	1.31
Net gain on foreign currency transactions and translations	89.88	91.71
Insurance claims	32.27	13.48
Scrap Sales (non-process)	14.07	6.94
Cash discount earned on early payments	10.74	43.35
Provisions and credit balances written back	3.90	6.44
Bad debts recovered	15.15	0.25
Profit on sale of tangible fixed assets written off/discarded	4.49	0.04
Provision on doubtful trade receivables/advances written back	0.30	35.06
Royalty income	0.94	-
Sundry income	1.27	0.41
Total	455.14	465.51

As we can see the other income includes income that is not related to the main business of the company. It includes interest on bank deposits, dividends, insurance claims, royalty income etc. Usually the other income forms (and it should) a small portion of the total income. A large 'other income' usually draws a red flag and it would demand a further investigation.

So adding up revenue from operations (Rs.3436 Crs) and other income (Rs.45 Crs), we have the total revenue of for FY14 at Rs.3482Crs.

Key takeaways from this chapter

1. The financial statement provides information and conveys the financial position of the company
2. A complete set of financial statements include the Profit & Loss Account, Balance Sheet and Cash Flow Statement
3. A fundamental Analyst is a user of financial statement, and he just needs to know what the maker of the financial statements states
4. The profit and loss statement gives the profitability of the company for the year under consideration
5. The P&L statement is an estimate, as the company can revise the numbers at a later point. Also by default companies publish data for the current year and the previous year, side by side
6. The revenue side of the P&L is also called the top line of the company
7. Revenue from operations is the main source of revenue for the company
8. Other operating income includes revenue incidental to the business

9. The other income includes revenue from non operating sources
10. The sum of revenue from operations (net of duty), other operating income, and other incomes gives the 'Net Revenue from Operations'

Understanding P&L Statement (Part 2)

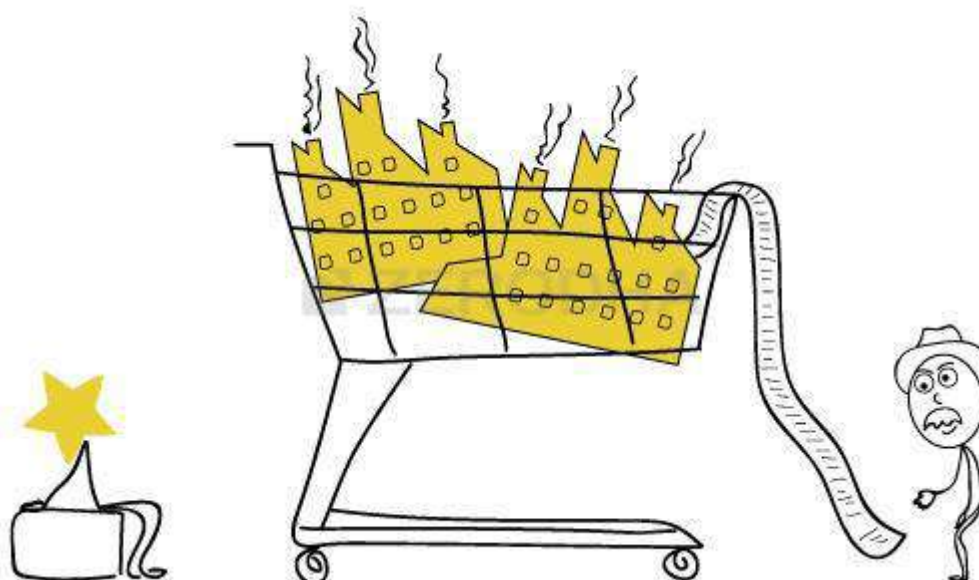

5.1 – The Expense details

In the previous chapter we had learnt about the revenues a company generates. Moving further on the P&L statement, in this chapter we will look at the expense side of the Profit and Loss Statement along with the associated notes. Expenses are generally classified according to their function, which is also called the cost of sales method or based on the nature of expense. An analysis of the expenses must be shown in the Profit and Loss statement or in the notes. As you can see in the extract below almost all the line items have a note associated to it.

EXPENSES			
Cost of materials consumed	19	21,011.95	17,603.12
Purchases of stock-in-trade	20	2,113.69	2,632.54
Changes in inventories of finished goods, work-in-process and stock-in-trade	20	(292.10)	(320.89)
Employee benefits expense	21	1,583.16	1,262.30
Finance costs	22	7.18	2.69
Depreciation and amortisation expense [includes impairment loss of ₹Nil (PY ₹75.52 million)]	23	645.71	660.92
Other expenses	24	4,346.60	3,904.24
Total Expenses		29,416.19	25,744.92

The first line item on the expense side is 'Cost of materials consumed'; this is invariably the cost of raw material that the company requires to manufacture

finished goods. As you can see the cost of raw material consumed/raw material is the largest expense incurred by the company. This expense stands at Rs.2101 Crs for the FY14 and Rs.1760 Crs for the FY13. Note number 19 gives the associated details for this expense, let us inspect the same.

NOTE 19: COST OF MATERIALS CONSUMED (Contd.)

a) Materials consumed comprise ₹ million

Particulars	Year ended March 31, 2014	Year ended March 31, 2013
Lead	9,882.97	8,221.83
Lead alloys	8,183.44	6,646.43
Separator	895.49	799.95
Others	2,050.05	1,934.91
Total	21,011.95	17,603.12

As you can see note 19 gives us the details of the material consumed. The company uses lead, lead alloys, separators and other items all of which adds up to Rs.2101 Crs.

The next two line items talks about 'Purchases of Stock in Trade' and 'Change in Inventories of finished goods , work-in-process & stock-in-trade'. Both these line items are associated with the same note (Note 20).

Purchases of stock in trade, refers to all the purchases of finished goods that the company buys towards conducting its business. This stands at Rs.211 Crs. I will give you more clarity on this line item shortly.

Change in inventory of finished goods refers to the costs of manufacturing incurred by the company in the past , but the goods manufactured in the past were sold in the present/current financial year. This stands at (Rs.29.2) Crs for the FY14.

A negative number indicates that the company produced more batteries in the FY14 than it managed to sell. To give a sense of proportion (in terms of sales and costs of sales) the company deducts the cost incurred in manufacturing the extra goods from the current year costs. The company will add this cost when they manage to sell these extra products sometime in future. This cost, which the company adds back later, will be included in the "Purchases of Stock in Trade" line item.

Here is an extract of Note 20 which details the above two line items:

NOTE 20: PURCHASES OF STOCK IN TRADE AND CHANGES IN INVENTORIES OF FINISHED GOODS, WORK-IN-PROCESS AND STOCK-IN-TRADE

a) PURCHASE OF STOCK-IN-TRADE ₹ million

Particulars	Year ended March 31, 2014	Year ended March 31, 2013
Storage batteries	1,619.44	1,437.71
Home UPS	494.25	1,194.83
Total	2,113.69	2,632.54

b) CHANGES IN INVENTORIES OF FINISHED GOODS, WORK-IN-PROCESS AND STOCK-IN-TRADE ₹ million

Particulars	Year ended March 31, 2014	Year ended March 31, 2013
Work-in-process		
Opening stock - Storage batteries	828.95	811.41
Less: Closing stock - Storage batteries	1,052.11	(223.16)
Finished goods		
Opening stock - Storage batteries	536.44	563.49
Less: Closing stock - Storage batteries	941.75	536.44
	(405.31)	27.05
Less: Excise Duty on (increase) / decrease of finished goods	(41.95)	(363.36)
		6.12
		20.93
Stock-in-trade		
Opening stock - Storage batteries	145.01	21.15
- Home UPS	223.97	23.55
	368.98	44.70
Less: Closing stock - Storage batteries	36.73	145.01
- Home UPS	37.83	223.97
	74.56	368.98
Net increase in inventories	(292.10)	(324.89)

The details mentioned on the above extract are quite straightforward and is easy to understand. At this stage it may not be necessary to dig deeper into this note. It is good to know where the grand total lies. However, when we take up 'Financial Modeling' as a separate module we will delve deeper into this aspect.

The next line item on the expense side is "Employee Benefit Expense". This is quite intuitive as it includes expense incurred in terms of the salaries paid, contribution towards provident funds, and other employee welfare expenses. This stands at Rs.158 Crs for the FY14. Have a look at the extract of note 21 which details the 'Employee Benefit Expense'.

NOTE 21: EMPLOYEE BENEFITS EXPENSE ₹ million

Particulars	Year ended March 31, 2014	Year ended March 31, 2013
Salaries and wages	1,361.32	1,086.99
Contribution to provident and other funds	81.54	69.81
Staff welfare expenses	140.30	105.50
Total	1,583.16	1,262.30

Here is something for you to think about – A company generating Rs.3482 Crs is spending only Rs.158 Crs or just 4.5% of its sales on its employees. In fact this is the pattern across most of companies (at least non IT). Perhaps it is time for you to rethink about that entrepreneurial dream you may have nurtured.

The next line item is the "Finance Cost / Finance Charges/ Borrowing Costs". Finance cost is interest costs and other costs that an entity pays when it borrows funds. The

interest is paid to the lenders of the company. The lenders could be banks or private lenders. The company's finance cost stands at Rs.0.7 Crs for the FY14. We will discuss more about the debt and related matters when we take up the chapter on the balance sheet later.

Following the finance cost the next line item is "Depreciation and Amortization" costs which stand at Rs.64.5 Crs. To understand depreciation and amortization we need to understand the concept of tangible and intangible assets.

A tangible asset is one which has a physical form and provides an economic value to the company. For example a laptop, a printer, a car, plants, machinery, buildings etc.

An intangible asset is something that does not have a physical form but still provides an economic value to the company such as brand value, trademarks, copyrights, patents, franchises, customer lists etc.

An asset (tangible or intangible) has to be depreciated over its useful life. Useful life is defined as the period during which the asset can provide economic benefit to the company. For example the useful life of a laptop could be 4 years. Let us understand depreciation better with the help of the following example.

Zerodha, a stock broking firm generates Rs.100,000/- from the stock broking business. However Zerodha incurred an expense of Rs.65,000/- towards the purchase of a high performance computer server. The economic life (useful life) of the server is expected to be 5 years. Now if you were to look into the earning capability of Zerodha it appears that on one hand Zerodha earned Rs.100,000/- and on the other hand spent Rs.65,000/- and therefore retained just Rs.35,000/-. This skews the earnings data for the current year and does not really reflect the true earning capability of the company.

Remember the asset even though purchased this year, would continue to provide economic benefits over its useful life. Hence it makes sense to spread the cost of acquiring the asset over its useful life. This is called depreciation. This means instead of showing an upfront lump sum expense (towards purchase of an asset), the company can show a smaller amount spread across the useful life of an asset.

Thus Rs.65,000/- will be spread across the useful life of the server, which is 5. Hence $65,000 / 5 = \text{Rs.}13,000/-$ would be depreciated every year over the next five years. By depreciating the asset, we are spreading the upfront cost. Hence after the depreciation computation, Zerodha would now show its earnings as $\text{Rs.}100,000 - \text{Rs.}13,000 = \text{Rs.}87,000/-$.

We can do a similar exercise for non tangible assets. The depreciation equivalent for non tangible assets is called amortization.

Now here is an important idea – Zerodha depreciates the cost of acquiring an asset over its useful life. However, in reality there is an actual outflow of Rs.65,000/- paid

towards the asset purchase. But now, it seems like the P&L is not capturing this outflow. As an analyst, how do we get a sense of the cash movement? Well, the cash movement is captured in the cash flow statement, which we will understand in the later chapters.

Here is the snapshot of Note 23, detailing the depreciation cost.

Particulars	Year ended March 31, 2014	Year ended March 31, 2013
Depreciation	634.41	652.72
Amortisation	11.30	8.20
Total	645.71	660.92

Note: Depreciation includes impairment provision on freehold land of ₹NIL (PY ₹75.52 million).

The last line item on the expense side is “other expenses” at Rs.434.6 Crs. This is a huge amount classified under ‘other expenses’, hence it deserves a detailed inspection.

Particulars	Year ended March 31, 2014	Year ended March 31, 2013
A. Manufacturing expenses		
a. Stores and spares consumed (including packing material)	449.41	378.41
b. Power and fuel	922.56	978.14
c. Insurance	8.49	7.29
d. Repairs and maintenance to		
i) Machinery	44.46	55.79
ii) Buildings	18.72	63.18
	14.28	70.07
Total (A)	1,443.64	1,433.91
B. Selling expenses		
a. Advertisement and promotion	275.85	154.41
b. Freight outward	595.20	553.25
c. Commission on sales	8.40	10.13
d. Service expenses	219.36	94.16
e. Warehousing and secondary freight	250.50	223.43
f. Other sales expenses	242.15	155.81
g. Royalty on sales	-	0.05
h. Product warranties	383.15	494.62
Total (B)	1,974.61	1,685.86

NOTE 24: OTHER EXPENSES (Contd.)

₹ million

Particulars	Year ended March 31, 2014	Year ended March 31, 2013
C. Administrative expenses		
a. Rent	114.10	98.31
b. Commission to Non-Executive Chairman	175.99	140.88
c. Payment to Auditors (Refer Note No. 28)	3.92	2.73
d. Research and development expenses	4.00	2.83
e. Donations	135.42	112.23
f. Travel and conveyance	147.00	116.70
g. Repairs and maintenance to office equipment	18.50	10.27
h. Communication expenses	18.81	16.58
i. Consultancy charges	34.45	39.18
j. Information technology expenses	26.62	18.71
k. Office maintenance expenses	92.79	83.24
l. Loss on sale of current investments	0.20	-
m. Sundry expenses	96.52	77.71
Total (C)	868.32	719.37
D. Other expenses		
a. Provision for doubtful trade receivables	0.07	-
b. Bad debts and irrecoverable advances written off	32.33	4.84
Less: Opening provision reversed	30.27	3.63
c. Tangible fixed assets written off	24.90	44.27
d. Premium on forward contracts	1.08	-
Total (D)	28.11	45.48
E. Rates and taxes (excluding Income tax)		
a. Rates, taxes and licenses	5.57	3.63
b. Duties and taxes (indirect taxes)	24.35	14.16
c. Wealth tax	2.00	1.83
Total (E)	31.92	19.62
Grand Total (A+B+C+D+E)	4,346.60	3,904.24

From the note it is quite clear that other expenses include manufacturing, selling, administrative and other expenses. The details are mentioned in the note. For example, Amara Raja Batteries Limited (ARBL) spent Rs.27.5 Crs on advertisement and promotional activities.

Adding up all the expenses mentioned in the expense side of P&L, it seems that Amara Raja Batteries has spent Rs.2941.6 Crs.

5.2 – The Profit before tax

It refers to the net operating income after deducting operating expenses but before deducting taxes and interest. Proceeding further on the P&L statement we can see that ARBL has mentioned their profit before tax and exceptional item numbers.

Simply put the profit before tax (PBT) is:

Profit before Tax = Total Revenues – Total Operating Expenses

= Rs.3482 – Rs.2941.6

=Rs.540.5

However there seems to be an exceptional item/ extraordinary item of Rs.3.8 Crs, which needs to be deducted. Exceptional items/ extraordinary items are expenses

occurring at one odd time for the company and the company does not foresee this as a recurring expense. Hence they treat it separately on the P&L statement.

Hence profit before tax and extraordinary items will be:

$$= 540.5 - 3.88$$

= Rs.536.6 Crs

The snapshot below (extract from P&L) shows the PBT(Profit Before Tax) of ARBL:

Profit before exceptional items and tax		5,405.54	4,309.74
Less: Exceptional items (net)	33	38.84	91.57
Profit before tax		5,366.70	4,218.17

5.3 – Net Profit after tax

The net operating profit after tax is defined as the company's operating profit after deducting its tax liability. We are now looking into the last part of the P&L statement, which is the profit after tax. This is also called the bottom line of the P&L statement.

Profit before tax		5,366.70	4,218.17
Less: Tax expense			
Current tax		1,580.00	1,377.97
Deferred tax (credit) / expense		106.23	(24.51)
Earlier year's (excess) / short provision		6.11	(2.34)
Profit for the year		3,674.36	2,867.05
Basic and diluted earnings per equity share of ₹1 each	37	21.51	16.78

As you can see from the snapshot above, to arrive at the profit after tax (PAT) we need to deduct all the applicable tax expenses from the PBT. Current tax is the corporate tax applicable for the given year. This stands at Rs.158 Crs. Besides this, there are other taxes that the company has paid. All taxes together total upto Rs.169.21 Crs. Deducting the tax amount from the PBT of Rs.536.6 gives us the profit after tax (PAT) at Rs.367.4 Crs.

Hence Net **PAT = PBT – Applicable taxes.**

The last line in the P&L statement talks about basic and diluted earnings per share. The EPS is one of the most frequently used statistics in financial analysis. EPS also serves as a means to assess the stewardship and management role performed by the company directors and managers. The earnings per share (EPS) is a very sacred number which indicates how much the company is earning per face value of the ordinary share. It appears that ARBL is earning Rs.21.51 per share. The detailed calculation is as shown below:

NOTE 37: EARNINGS PER SHARE

Particulars	Year ended March 31, 2014	Year ended March 31, 2013
Numerator - Earnings		
Net profits for the period in ₹ million	3,674.36	2,867.05
Denominator - Equity shares		
Number of shares at the beginning of the year	17,08,12,500	17,08,12,500
Add: Shares issued during the year	-	-
Less: Shares forfeited / bought back during the year	-	-
Number of shares outstanding at the end of the year	17,08,12,500	17,08,12,500
Weighted average number of shares outstanding at the end of the year (Basic and Diluted)	17,08,12,500	17,08,12,500
Basic and diluted earnings per equity share of ₹1 each	₹21.51	₹16.78

The company indicates that there are 17,08,12,500 shares outstanding in the market. Dividing the total profit after tax number by the outstanding number of shares, we can arrive at the earnings per share number. In this case:

Rs.367.4 Crs divided by 17,08,12,500 yields Rs.21.5 per share.

5.4 – Conclusion

Now that we have gone through all the line items in the P&L statement let us relook at it in its entirety.

Statement of Profit and Loss for the year ended March 31, 2014.

₹ million

Particulars	Note No.	Year ended March 31, 2014	Year ended March 31, 2013
REVENUE			
Sale of products		38,041.27	32,949.37
Less: Excise duty		4,005.15	3,512.45
Net sale of products		34,036.12	29,436.92
Sale of services		309.32	137.02
Other operating revenue		21.15	15.21
Net revenue from operations	17	34,366.59	29,589.15
Other income	18	455.14	465.51
Total Revenue		34,821.73	30,054.66
EXPENSES			
Cost of materials consumed	19	21,011.95	17,603.12
Purchases of stock-in-trade	20	2,113.69	2,632.54
Changes in inventories of finished goods, work-in-process and stock-in-trade	20	(292.10)	(320.89)
Employee benefits expense	21	1,583.16	1,262.30
Finance costs	22	7.18	2.69
Depreciation and amortisation expense (includes impairment loss of ₹Nil (PY ₹75.52 million))	23	645.71	660.92
Other expenses	24	4,346.60	3,904.24
Total Expenses		29,416.19	25,744.92
Profit before exceptional items and tax		5,405.54	4,309.74
Less: Exceptional items (net)	33	38.84	91.57
Profit before tax		5,366.70	4,218.17
Less: Tax expense			
Current tax		1,580.00	1,377.97
Deferred tax (credit) / expense		106.23	(24.51)
Earlier year's (excess) / short provision		6.11	(2.34)
Profit for the year		3,674.36	2,867.05
Basic and diluted earnings per equity share of ₹1 each	37	21.51	16.78

Hopefully, the statement above should look more meaningful to you by now. Remember almost all line items in the P&L statement will have an associated note. You can always look into the notes to seek greater clarity. Also at this stage we have just understood how to read the P&L statement, but we still need to analyze what the numbers mean. We will do this when we take up the financial ratios. Also, the P&L statement is very closely connected with the other two financial statements i.e the balance sheet and the cash flow statement. We will explore these connections at a later stage.

Key takeaways from this chapter:

1. The expense part of the P&L statement contains information on all the expenses incurred by the company during the financial year
2. Each expense can be studied with reference to a note which you can explore for further information

3. Depreciation and amortization is way of spreading the cost of an asset over its useful life
4. Finance cost is the cost of interest and other charges paid when the company borrows money for its capital expenditure.
5. $PBT = \text{Total Revenue} - \text{Total Expense} - \text{Exceptional items (if any)}$
6. $\text{Net PAT} = PBT - \text{applicable taxes}$
7. EPS reflects the earning capacity of a company on a per share basis. Earnings are profit after tax and preferred dividends.
8. $EPS = PAT / \text{Total number of outstanding ordinary shares}$

Understanding Balance Sheet Statement (Part 1)



6.1 – The balance sheet equation

While the P&L statement gives us information pertaining to the profitability of the company, the balance sheet gives us information pertaining to the assets, liabilities, and the shareholders equity. The P&L statement as you understood, discusses about the profitability for the financial year under consideration, hence it is good to say that the P&L statement is a standalone statement. The balance sheet however is prepared on a flow basis, meaning, it has financial information pertaining to the company right from the time it was incorporated. Thus while the P&L talks about how the company performed in a particular financial year; the balance sheet on the other hand discusses how the company has evolved financially over the years.

Have a look at the balance sheet of Amara Raja Batteries Limited (ARBL):

Balance Sheet as at March 31, 2014

₹ million

Particulars	Note No.	As at March 31, 2014	As at March 31, 2013
EQUITY AND LIABILITIES			
Shareholders' funds			
Share capital	2	170.81	170.81
Reserves and surplus	3	13,456.20	10,427.33
		13,627.01	10,598.14
Non-current liabilities			
Long-term borrowings	4	759.47	773.13
Deferred tax liabilities (net)	5	301.33	195.09
Long-term provisions	6	369.57	376.41
		1,430.37	1,344.63
Current liabilities			
Short-term borrowings	7	83.83	98.63
Trade payables	8	1,277.79	1,362.84
Other current liabilities	9	2,156.68	1,807.26
Short-term provisions	6	2,818.73	2,493.20
		6,337.03	5,761.93
Total		21,394.41	17,704.70
ASSETS			
Non-current assets			
Fixed assets			
Tangible assets	10	6,198.94	3,554.97
Intangible assets		32.96	33.69
Capital work-in-progress		1,443.60	1,024.97
Intangible assets under development		3.14	4.84
		7,678.64	4,618.47
Non-current investments	11	160.76	160.76
Long-term loans and advances	12	567.69	353.52
Other non-current assets	13	1.22	3.43
		8,408.31	5,136.18
Current assets			
Inventories	14	3,350.08	2,928.58
Trade receivables	15	4,527.89	3,806.77
Cash and bank balances	16	2,945.67	4,107.90
Short-term loans and advances	12	2,119.30	1,656.78
Other current assets	13	43.16	68.49
		12,986.10	12,568.52
Total		21,394.41	17,704.70
Significant accounting policies	1		

Statement on significant accounting policies and notes are an integral part of the financial statements

As you can see the balance sheet contains details about the assets, liabilities, and equity.

We had discussed about assets in the previous chapter. **Assets**, both tangible and intangible are owned by the company. An asset is a resource controlled by the company, and is expected to have an economic value in the future. Typical examples of assets include plants, machinery, cash, brands, patents etc. Assets are of two types, current and non-current, we will discuss these later in the chapter.

Liability on the other hand represents the company's obligation. The obligation is taken up by the company because the company believes these obligations will provide economic value in the long run. Liability in simple words is the loan that the company has taken and it is therefore obligated to repay back. Typical examples of obligation include short term borrowing, long term borrowing, payments due etc. Liabilities are of two types namely current and non-current. We will discuss about the kinds of liabilities later on in the chapter.

In any typical balance sheet, the total assets of company should be equal to the total liabilities of the company. Hence,

Assets = Liabilities

The equation above is called the balance sheet equation or the accounting equation. In fact this equation depicts the key property of the balance sheet i.e the balance sheet should always be balanced. In other word the Assets of the company should be equal to the Liabilities of the company. This is because everything that a company owns (Assets) has to be purchased either from either the owner's capital or liabilities.

Owners Capital is the difference between the Assets and Liabilities. It is also called the 'Shareholders Equity' or the 'Net worth'. Representing this in the form of an equation :

Share holders equity = Assets - Liabilities

6.2 –A quick note on shareholders' funds

As we know the balance sheet has two main sections i.e. the assets and the liabilities. The liabilities as you know represent the obligation of the company. The shareholders' fund, which is integral to the liabilities side of the balance sheet, is highlighted in the snapshot below. Many people find this term a little confusing.

Balance Sheet as at March 31, 2014 ₹ million

Particulars	Note No.	As at March 31, 2014	As at March 31, 2013
EQUITY AND LIABILITIES			
Shareholders' funds			
Share capital	2	170.81	170.81
Reserves and surplus	3	13,456.20	10,427.33
		13,627.01	10,598.14
Non-current liabilities			
Long-term borrowings	4	759.47	773.13
Deferred tax liabilities (net)	5	301.33	195.09
Long-term provisions	6	369.57	376.41
		1,430.37	1,344.63
Current liabilities			
Short-term borrowings	7	83.83	98.63
Trade payables	8	1,277.79	1,362.84
Other current liabilities	9	2,156.68	1,807.26
Short-term provisions	6	2,818.73	2,493.20
		6,337.03	5,761.93
Total		21,394.41	17,704.70

If you think about it, on one hand we are discussing about liabilities which represent the obligation of the company, and on the other hand we are discussing the shareholders' fund which represents the shareholders' wealth. This is quite counter intuitive isn't it? How can liabilities and shareholders' funds appear on the 'Liabilities' side of balance sheet? After all the shareholders funds represents the funds belonging to its shareholders' which in the true sense is an asset and not really a liability.

To make sense of this, you should change the perspective in which you look at a company's financial statement. Think about the entire company as an individual, whose sole job is run its core operation and to create wealth to its shareholders'. By thinking this way, you are in fact separating out the shareholders' (which also includes its promoters) and the company. With this new perspective, now think about the financial statement. You will appreciate that, the financial statements is a statement published by the company (which is an entity on its own) to communicate to the world about its financial well being.

This also means the shareholders' funds do not belong to the company as it rightfully belongs to the company's shareholders'. Hence from the company's perspective the shareholders' funds are an obligation payable to shareholders'. Hence this is shown on the liabilities side of the balance sheet.

6.3 –The liability side of balance sheet

The liabilities side of the balance sheet details out all the liabilities of the company. Within liabilities there are three sub sections – shareholders' fund, non-current liabilities, and current liabilities. The first section is the shareholders' funds.

Particulars	Note No.	As at March 31, 2014	As at March 31, 2013
EQUITY AND LIABILITIES			
Shareholders' funds			
Share capital	2	170.81	170.81
Reserves and surplus	3	13,456.20	10,427.33
		13,627.01	10,598.14

To understand share capital, think about a fictional company issuing shares for the first time. Imagine, Company ABC issues 1000 shares, with each share having a face value of Rs.10 each. The share capital in this case would be $Rs.10 \times 1000 = Rs.10,000/-$ (Face value X number of shares).

In the case of ARBL, the share capital is Rs.17.081 Crs (as published in the Balance Sheet) and the Face Value is Rs.1/-. I got the FV value from the NSE's website:

Amara Raja Batteries Limited

Series: EQ |

Symbol: AMARAJABAT ISIN: INE885A01032

Market Tracker

634.70 ▼ -4.05 -0.63%	Pr. Close 638.75	Open 631.05	High 641.90	Low 624.05	Close -
---------------------------------	---------------------	----------------	----------------	---------------	------------

Trade Snapshot	Company Information	Peer Comparison	Historical Data
	Print	Order Book	Intra-day Chart
VWAP	633.86	Stock V/s Index Chart	Quarterly Charts
Face Value	1.00	Buy Qty.	Buy Price
Traded Volume (shares)	1,04,215		Sell Price
Traded Value (lacs)	660.58		Sell Qty.
Free Float Market Cap(Crs)	5,230.41		
52 week high	674.95 (12-SEP-14)		
52 week low	288.00 (01-OCT-13)		
Adjusted 52 week high	-		
Adjusted 52 week low	-		
Lower Price Band	511.00		
Upper Price Band	766.50		
Note:			

Buy Qty.	Buy Price	Sell Price	Sell Qty.
3	634.70	635.00	32
25	633.20	635.30	50
10	633.15	635.55	72
10	633.10	635.60	15
12	632.80	635.70	50
30,213	Total Quantity		35,663

Security-wise Delivery Position (19SEP2014)
 Value at Risk (VaR in %)

I can use the FV and share capital value to calculate the number of shares outstanding. We know:

$$\text{Share Capital} = \text{FV} * \text{Number of shares}$$

Therefore,

$$\text{Number of shares} = \text{Share Capital} / \text{FV}$$

Hence in case of ARBL,

$$\text{Number of shares} = 17,08,10,000 / 1$$

$$= \mathbf{17,08,10,000 \text{ shares}}$$

The next line item on the liability side of the Balance Sheet is the 'Reserves and Surplus'. Reserves are usually money earmarked by the company for specific purposes. Surplus is where all the profits of the company reside. The reserves and surplus for ARBL stands at Rs.1,345.6 Crs. The reserves and surplus have an associated note, numbered 3. Let us look into the same.

NOTE 3: RESERVES AND SURPLUS

₹ million

Particulars	As at March 31, 2014	As at March 31, 2013
Capital reserve		0.01
Securities premium account		311.86
General reserve		
As per last Balance Sheet	1,817.27	1,530.56
Add: Transfer from surplus in the Statement of Profit and Loss	367.44	286.71
	2,184.71	1,817.27
Surplus in the Statement of Profit and Loss		
As per last Balance Sheet	8,298.19	6,221.45
Add: Profit for the year	3,674.36	2,867.05
Amount available for appropriation	11,972.55	9,088.50
Less: Appropriations		
Transfer to general reserve	367.44	286.71
Proposed dividend	551.72	430.45
Dividend tax on proposed dividend	93.77	73.15
	10,959.62	8,298.19
Total	13,456.20	10,427.33

As you can notice from the note, the company has earmarked funds across three kinds of reserves:

1. **Capital reserves** – Usually earmarked for long term projects. Clearly ARBL does not have much amount here. This amount belongs to the shareholders, but cannot be distributed to them.
2. **Securities premium reserve / account** – This is where the premium over and above the face/par value of the shares sits. ARBL has a Rs.31.18 Crs under this reserve
3. **General reserve** – This is where all the accumulated profits of the company which is not yet distributed to the shareholder reside. The company can use the money here as a buffer. As you can see ARBL has Rs.218.4 Crs in general reserves.

The next section deals with the surplus. As mentioned earlier, surplus holds the profits made during the year. Couple of interesting things to note:

1. As per the last year (FY13) balance sheet the surplus was Rs.829.8Crs. This is what is stated as the opening line under surplus. See the image below:

NOTE 3: RESERVES AND SURPLUS

₹ million

Particulars	As at March 31, 2014	As at March 31, 2013
Capital reserve		0.01
Securities premium account		311.86
General reserve		
As per last Balance Sheet	1,817.27	1,530.56
Add: Transfer from surplus in the Statement of Profit and Loss	367.44	286.71
	2,184.71	1,817.27
Surplus in the Statement of Profit and Loss		
As per last Balance Sheet	8,298.19	6,221.45
Add: Profit for the year	3,674.36	2,867.05
Amount available for appropriation	11,972.55	9,088.50
Less: Appropriations		
Transfer to general reserve	367.44	286.71
Proposed dividend	551.72	430.45
Dividend tax on proposed dividend	93.77	73.15
	10,959.62	8,298.19
Total	13,456.20	10,427.33

1. The current year (FY14) profit of Rs.367.4 Crs is added to previous years closing balance of surplus. Few things to take note here:
 1. Notice how the bottom line of P&L is interacting with the balance sheet. This highlights a very important fact – all the three financial statements are closely related
 2. Notice how the previous year balance sheet number is added up to this year's number. This highlights the fact that the balance sheet is prepared on a flow basis, adding the carrying forward numbers year on year
2. Previous year's balance plus this year's profit adds up to Rs.1197.2 Crs. The company can choose to apportion this money for various purposes.
 1. The first thing a company does is it transfers some money from the surplus to general reserves so that it will come handy for future use. They have transferred close to Rs.36.7 Crs for this purpose
 2. After transferring to general reserves they have distributed Rs.55.1 Crs as dividends over which they have to pay Rs.9.3 Crs as dividend distribution taxes.
 3. After making the necessary apportions the company has Rs.1095.9 Crs as surplus as closing balance. This as you may have guessed will be the opening balance for next year's (FY15) surplus account.
 4. Total Reserves and Surplus = Capital reserve + securities premium reserve + general reserves + surplus for the year. This stands at Rs.1345.6 Crs for the FY 14 against Rs.1042.7 Crs for the FY13

The total shareholders' fund is a sum of share capital and reserves & surplus. Since this amount on the liability side of the balance sheet represents the money belonging to shareholders', this is called the 'shareholders funds'.

6.4 – Non Current Liabilities

Non-current liabilities represent the long term obligations, which the company intends to settle/ pay off not within 365 days/ 12 months of the balance sheet date. These obligations stay on the books for few years. Non-current liabilities are generally settled after 12 months after the reporting period.

Here is the snapshot of the non-current liabilities of Amara Raja batteries Ltd.

Non-current liabilities				
Long-term borrowings	4	759.47		773.13
Deferred tax liabilities (net)	5	301.33		195.09
Long-term provisions	6	369.57		376.41
			1,430.37	1,344.63

The company has three types of non-current liabilities; let us inspect each one of them.

The long term borrowing (associated with note 4) is the first line item within the non-current liabilities. Long term borrowing is one of the most important line item in the entire balance sheet as it represents the amount of money that the company has borrowed through various sources. Long term borrowing is also one of the key

inputs while calculating some of the financial ratios. Subsequently in this module we will look into the financial ratios.

Let us look into the note associated with 'Long term borrowings':

NOTE 4: LONG-TERM BORROWINGS ₹ million

Particulars	Non-current portion		Current maturities	
	As at March 31, 2014	As at March 31, 2013	As at March 31, 2014	As at March 31, 2013
Deferred payment liabilities				
Interest free sales tax deferment (Unsecured)	759.47	773.13	13.66	9.27
Total	759.47	773.13	13.66	9.27

Interest free sales tax deferment
 The Company has availed interest free sales tax deferment under Andhra Pradesh sales tax deferment scheme (Target 2000) from the financial year 1997-98 as per the eligibility norms in respect of expanded capacities. The Company has availed total deferment of ₹811.40 million since March, 1998, which is repayable after a period of 14 years from the date of each availment in annual installments.

- Eligible amount of interest free sales tax deferment - ₹813.33 million
- Period eligible for availment - January 1998 till September 2015

From the note it is quite clear that the 'Long term borrowings' is in the form of 'interest free sales tax deferment'. To understand what interest free sales tax deferment really means, the company has explained just below the note (I have highlighted the same in a red box). It appears to be some sort of tax incentive from the state government. The company plans to settle this amount over a period of 14 years.

You will find that there are many companies which do not have long term borrowings (debt). While it is a good to know that the company has no debt, you must also question as to why there is no debt? Is it because the banks are refusing to lend to the company? or is it because the company is not taking initiatives to expand their business operations. Of course, we will deal with the analysis part of the balance sheet later in the module.

Do recollect, we looked at 'Finance Cost' as a line item when we looked at the P&L statement. If the debt of the company is high, then the finance cost will also be high.

The next line item within the non-current liability is '**Deferred Tax Liability**'. The deferred tax liability is basically a provision for future tax payments. The company foresees a situation where it may have to pay additional taxes in the future; hence they set aside some funds for this purpose. Why do you think the company would put itself in a situation where it has to pay more taxes for the current year at some point in the future?

Well this happens because of the difference in the way depreciation is treated as per Company's act and Income tax. We will not get into this aspect as we will digress from our objective of becoming users of financial statements. But do remember, deferred tax liability arises due to the treatment of depreciation.

The last line item within the non-current liability is the **'Long term provisions'**. Long term provisions are usually money set aside for employee benefits such as gratuity; leave encashment, provident funds etc.

6.5 – Current liabilities

Current liabilities are a company's obligations which are expected to be settled within 365 days (less than 1 year). The term 'Current' is used to indicate that the obligation is going to be settled soon, within a year. Going by that 'non-current' clearly means obligations that extend beyond 365 days.

Think about this way – if you buy a mobile phone on EMI (via a credit card) you obviously plan to repay your credit card company within a few months. This becomes your 'current liability'. However if you buy an apartment by seeking a 15 year home loan from a housing finance company, it becomes your 'non-current liability'.

Here is the snapshot of ARBL's current liabilities:

Current liabilities			
Short-term borrowings	7	83.83	98.63
Trade payables	8	1,277.79	1,362.84
Other current liabilities	9	2,156.68	1,807.26
Short-term provisions	6	2,818.73	2,493.20

As you can see there are 4 line items within the current liabilities. The first one is the short term borrowings. As the name suggests, these are short term obligations of the company usually undertaken by the company to meet day to day cash requirements (also called working capital requirements). Here is the extract of note 7, which details what short term borrowings mean:

NOTE 7: SHORT-TERM BORROWINGS		₹ million	
Particulars	As at March 31, 2014	As at March 31, 2013	
Loans repayable on demand			
Cash credit from banks (Secured)			
State Bank of India	56.57	98.63	
Andhra Bank	27.26	-	
Total	83.83	98.63	

The working capital facilities from State Bank of India, State Bank of Hyderabad, Andhra Bank and The Bank of Nova Scotia are secured by hypothecation of all current assets of the Company. The fixed assets of the Company are provided as collateral security by way of pari-passu second charge for the working capital facilities availed from State Bank of India.

Clearly as you can see, these are short term loans availed from the State bank of India and Andhra Bank towards meeting the working capital requirements. It is interesting to note that the short term borrowing is also kept at low level, at just Rs.8.3Cr.

The next line item is Trade Payable (also called account payable) which is at Rs.127.7 Crs. These are obligations payable to vendors who supply to the company. The vendors could be raw material suppliers, utility companies providing services, stationary companies etc. Have a look at note 8 which gives the details:

NOTE 8: TRADE PAYABLES ₹ million

Particulars	As at March 31, 2014	As at March 31, 2013
(Unsecured)		
Trade payables		
i) Dues to Micro, Small and Medium Enterprises	4.87	7.17
ii) Others	1,272.92	1,355.67
Total	1,277.79	1,362.84

Notes relating to Micro, Small and Medium Enterprises

Based on, and to the extent of information received from the suppliers with regard to their status under Micro, Small and Medium Enterprises Development Act, 2006 (MSMED Act), on which the auditors have relied, the disclosure requirements of Schedule VI to the Companies Act, 1956 with regard to the payments made/due to Micro, Small and Medium Enterprises are given below:

The next line item just says 'Other current liabilities' which stands at Rs.215.6 Crs. Usually 'Other current Liabilities' are obligations associated with the statutory requirements and obligations that are not directly related to the operations of the company. Here is note 9 associated with 'Other current liabilities':

Notes forming part of the Financial Statements

NOTE 9: OTHER CURRENT LIABILITIES ₹ million

Particulars	As at March 31, 2014	As at March 31, 2013
(Unsecured)		
Unclaimed dividends*	17.04	13.22
Other payables		
a) Employee related payables	370.12	311.60
b) Outstanding liabilities	860.06	643.10
c) Commission payable to Non-Executive Chairman	175.99	140.88
d) Excise duty/Service tax payable	15.36	4.17
e) Sales tax payables	169.88	200.39
f) TDS/TCS payables	31.31	14.48
g) Advances from customers	25.02	42.52
h) Creditors for capital goods/services	176.30	214.15
i) Other non-trade payables	301.94	213.48
Sub-Total	2,125.98	1,784.77
Add: Current maturities of long-term debt (Refer Note No. 4)		
Interest free sales tax deferment (Unsecured) repayable within 12 months	13.66	9.27
Total	2,156.68	1,807.26

*The unclaimed dividends represent those relating to the years 2006-07 to 2012-13 (for previous year from 2005-06 to 2011-12) and no part thereof has remained unpaid or unclaimed for a period of seven years or more from the date they became due for payment requiring transfer to the Investor Education and Protection Fund.

The last line item in current liabilities is the 'Short term provisions' which stands at Rs.281.8 Crs. Short term provisions is quite similar to long term provisions, both of which deals with setting aside funds for employee benefits such as gratuity, leave encashment, provident funds etc. Interestingly the note associated with 'Short term Provisions' and the 'Long term provisions' is the same. Have a look at the following:

Non-current liabilities				
Long-term borrowings	4	759.47		773.13
Deferred tax liabilities (net)	5	301.33		195.09
Long-term provisions	6	369.57		376.41
			1,430.37	1,344.63
Current liabilities				
Short-term borrowings	7	83.83		98.63
Trade payables	8	1,277.79		1,362.84
Other current liabilities	9	2,156.68		1,807.26
Short-term provisions	6	2,818.73		2,493.20

Since note 6 is detailing both long and short term provisions it runs into several pages, hence for this reason I will not represent an extract of it. For those who are curious to look into the same can refer to pages 80, 81, 82 and 83 in the FY14 Annual report for Amara Raja Batteries Limited.

However, from the user of a financial statement perspective all you need to know is that these line items (short and long term provisions) deal with the employee and related benefits. Please note, one should always look at the associated note to run through the details.

We have now looked through half of the balance sheet which is broadly classified as the Liabilities side of the Balance sheet. Let us relook at the balance sheet once again to get a perspective:

Balance Sheet as at March 31, 2014

₹ million

Particulars	Note No.	As at March 31, 2014	As at March 31, 2013
EQUITY AND LIABILITIES			
Shareholders' funds			
Share capital	2	170.81	170.81
Reserves and surplus	3	13,456.20	10,427.33
		13,627.01	10,598.14
Non-current liabilities			
Long-term borrowings	4	759.47	773.13
Deferred tax liabilities (net)	5	301.33	195.09
Long-term provisions	6	369.57	376.41
		1,430.37	1,344.63
Current liabilities			
Short-term borrowings	7	83.83	98.63
Trade payables	8	1,277.79	1,362.84
Other current liabilities	9	2,156.68	1,807.26
Short-term provisions	6	2,818.73	2,493.20
		6,337.03	5,761.93
Total		21,394.41	17,704.70
ASSETS			
Non-current assets			
Fixed assets			
Tangible assets	10	6,198.94	3,554.97
Intangible assets		32.96	33.69
Capital work-in-progress		1,443.60	1,024.97
Intangible assets under development		3.14	4.84
		7,678.64	4,618.47
Non-current investments	11	160.76	160.76
Long-term loans and advances	12	567.69	353.52
Other non-current assets	13	1.22	3.43
		8,408.31	5,136.18
Current assets			
Inventories	14	3,350.08	2,928.58
Trade receivables	15	4,527.89	3,806.77
Cash and bank balances	16	2,945.67	4,107.90
Short-term loans and advances	12	2,119.30	1,656.78
Other current assets	13	43.16	68.49
		12,986.10	12,568.52
Total		21,394.41	17,704.70
Significant accounting policies	1		

Statement on significant accounting policies and notes are an integral part of the financial statements

Clearly,

Total Liability = Shareholders' Funds + Non Current Liabilities + Current Liabilities

$$= 1362.7 + 143.03 + 633.7$$

Total Liability = Rs.2139.4 Crs

Key takeaways from this chapter

1. A Balance sheet also called the Statement of Financial Position is prepared on a flow basis which depicts the financial position of the company at any given point in time. It is a statement which shows what the company owns (assets) and what the company owes (liabilities)
2. A business will generally need a balance sheet when it seeks investors, applies for loans, submits taxes etc.
3. Balance sheet equation is $\text{Assets} = \text{Liabilities} + \text{Shareholders' Equity}$
4. Liabilities are obligations or debts of a business from past transactions and Share capital is $\text{number of shares} * \text{face value}$
5. Reserves are the funds earmarked for a specific purpose, which the company intends to use in future
6. Surplus is where the profits of the company reside. This is one of the points where the balance sheet and the P&L interact. Dividends are paid out of the surplus
7. $\text{Shareholders' equity} = \text{Share capital} + \text{Reserves} + \text{Surplus}$. Equity is the claim of the owners on the assets of the company. It represents the assets that remain after deducting the liabilities. If you rearrange the Balance Sheet equation, $\text{Equity} = \text{Assets} - \text{Liabilities}$.
8. Non-current liabilities or the long term liabilities are obligations which are expected to be settled in not less than 365 days or 12 months of the balance sheet date
9. Deferred tax liabilities arise due to the discrepancy in the way the depreciation is treated. Deferred tax liabilities are amounts of income taxes payable in the future with respect to taxable differences as per accounting books and tax books.
10. Current liabilities are the obligations the company plans to settle within 365 days /12 months of the balance sheet date.
11. In most cases both long and short term provisions are liabilities dealing with employee related matters
12. $\text{Total Liability} = \text{Shareholders' Funds} + \text{Non Current Liabilities} + \text{Current Liabilities}$. . Thus, total liabilities represent the total amount of money the company owes to others

Understanding the Balance Sheet Statement (Part 2)

7.1 – The Assets side of Balance Sheet

In the previous chapter we looked at the liability side of the balance sheet in detail. We will now proceed to understand the 2nd half of the balance sheet i.e the Asset side of the balance sheet. The Asset side shows us all the assets the company owns (in different forms) right from its inception. Assets in simple terms are the resources held by a company, which help in generating the revenues. Here is the snapshot of the Assets side of the balance sheet:

ASSETS				
Non-current assets				
Fixed assets	10			
Tangible assets		6,198.94		3,554.97
Intangible assets		32.96		33.69
Capital work-in-progress		1,443.60		1,024.97
Intangible assets under development		3.14		4.84
		7,678.64		4,618.47
Non-current investments	11	160.76		160.76
Long-term loans and advances	12	567.69		353.52
Other non-current assets	13	1.22		3.43
			8,408.31	5,136.18
Current assets				
Inventories	14	3,350.08		2,928.58
Trade receivables	15	4,527.89		3,806.77
Cash and bank balances	16	2,945.67		4,107.90
Short-term loans and advances	12	2,119.30		1,656.78
Other current assets	13	43.16		68.49
			12,986.10	12,568.52
Total			21,394.41	17,704.70

As you can see the Asset side has two main sections i.e Non-current assets and Current assets. Both these sections have several line items (with associated notes) included within. We will look into each one of these line items.

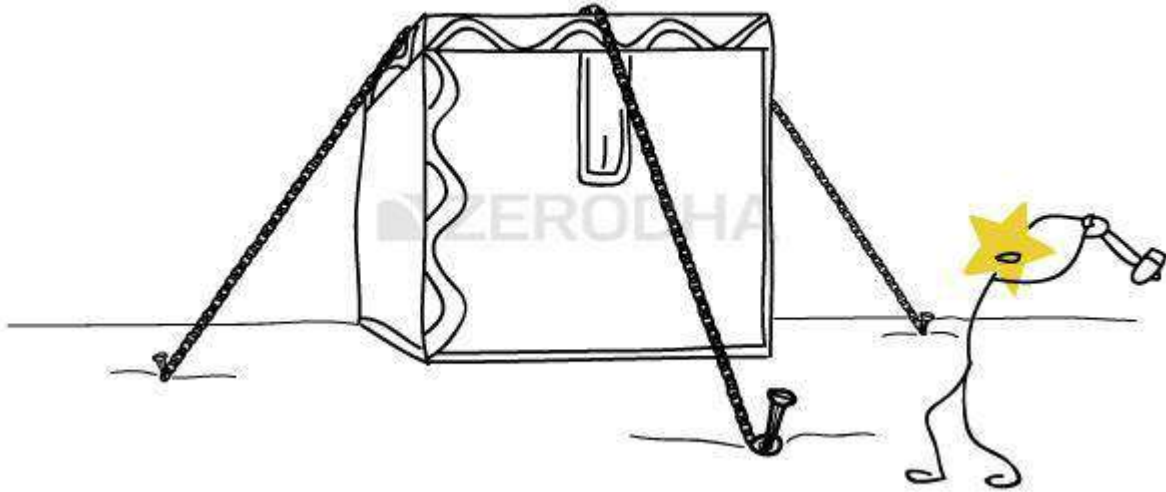

7.2 – Non-current assets (Fixed Assets)

Similar to what we learnt in the previous chapter, non-current assets talks about the assets that the company owns, the economic benefit of which is enjoyed over a long period (beyond 365 days). Remember an asset owned by a company is expected to give the company an economic benefit over its useful life.

If you notice within the non-current assets there is a subsection called “Fixed Assets” with many line items under it. Fixed assets are assets (both tangible and intangible) that the company owns which cannot be converted to cash easily or which cannot be liquidated easily. Typical examples of fixed assets are land, plant and machinery, vehicles, building etc. Intangible assets are also considered fixed assets because they benefit companies over a long period of time. If you see, all the line items within fixed assets have a common note, numbered 10, which we will explore in great detail shortly.

Here is the snapshot of fixed assets of Amara Raja Batteries Limited:

Fixed assets	10		
Tangible assets	6,198.94		3,554.97
Intangible assets	32.96		33.69
Capital work-in-progress	1,443.60		1,024.97
Intangible assets under development	3.14		4.84
	7,678.64		4,618.47

The first line item ‘Tangible Assets’ is valued at Rs.619.8Crs. Tangible assets consists of assets which has a physical form. In other words these assets can be seen or touched. This usually includes plant and machinery, vehicles, buildings, fixtures etc.

Likewise the next line item reports the value of Intangible assets valued at Rs.3.2 Crs. Intangible assets are assets which have an economic value, but do not have a physical nature. This usually includes patents, copyrights, trademarks, designs etc.

Remember when we discussed the P&L statement we discussed depreciation. Depreciation is a way of spreading the cost of acquiring the asset over its useful life. The value of the assets deplete over time, as the assets lose their productive capacity due to obsolescence and physical wear and tear. This value is called the Depreciation expense, which is shown in the Profit and Loss account and the Balance Sheet.

All the assets should be depreciated over its useful life. Keeping this in perspective, when the company acquires an asset it is called the 'Gross Block'. Depreciation should be deducted from the Gross block, after which we can arrive at the 'Net Block'.

Net Block = Gross Block - Accumulated Depreciation

Note, the term 'Accumulated' is used to indicate all the depreciation value since the incorporation of the company.

When we read tangible assets at Rs.619.8 Crs and Intangible assets at Rs.3.2 Crs, do remember the company is reporting its Net block, which is Net of Accumulated depreciation. Have a look at the Note 10, which is associated with fixed assets.

NOTE 10: FIXED ASSETS & DEPRECIATION

₹ million

Particulars	GROSS BLOCK				DEPRECIATION / AMORTISATION				IMPAIRMENT				NET BLOCK	
	As at March 31, 2013	Additions during the year	Deductions during the year	As at March 31, 2014	Upto March 31, 2013	For the year	On Deductions	Upto March 31, 2014	Upto March 31, 2013	For the year	On Deductions	Upto March 31, 2014	As at March 31, 2014	As at March 31, 2013
A. Tangible assets														
Land and land development														
- Freehold land	170.17	-	-	170.17	-	-	-	-	75.52	-	-	75.52	94.65	94.65
- Leasehold land*	133.65	267.86	-	401.51	0.84	2.22	-	3.06	-	-	-	-	398.45	132.81
Buildings	934.48	858.44	6.68	1,786.24	172.70	28.42	3.76	197.36	-	-	-	-	1,588.88	761.78
R&D buildings	9.90	9.03	-	18.93	4.59	0.48	-	5.07	-	-	-	-	13.86	5.31
Plant & machinery	4,549.43	1,950.56	121.13	6,378.86	2,527.37	522.95	105.11	2,945.21	-	-	-	-	3,433.65	2,022.06
R&D plant & machinery	118.84	36.85	9.75	145.94	81.90	12.84	8.95	85.79	-	-	-	-	60.15	36.94
Electrical installations	468.15	58.55	4.52	522.18	153.50	31.08	4.24	180.34	-	-	-	-	341.84	314.65
Furniture	79.25	21.56	0.002	100.81	42.45	4.87	0.002	47.32	-	-	-	-	53.49	36.80
Vehicles	105.50	37.65	12.54	130.61	33.81	9.73	10.07	33.47	-	-	-	-	97.14	71.69
Office equipment	181.06	63.16	6.71	237.51	102.78	24.09	6.19	120.68	-	-	-	-	116.83	78.28
Total	6,750.43	3,303.66	161.33	9,892.76	3,119.94	636.68	138.32	3,618.30	75.52	-	-	75.52	6,198.94	3,554.97
Previous year	6,181.26	724.78	155.61	6,750.43	2,656.46	578.04	114.56	3,119.94	-	75.52	-	75.52	3,554.97	3,524.80
B. Intangible assets														
Brands/trademarks	0.12	-	-	0.12	0.12	-	-	0.12	-	-	-	-	-	-
Computer software	52.08	10.30	-	62.38	18.39	11.04	-	29.43	-	-	-	-	37.95	33.69
Total	52.20	10.30	-	62.50	18.51	11.04	-	29.55	-	-	-	-	37.95	33.69
Previous year	31.23	20.97	-	52.20	10.31	8.20	-	18.51	-	-	-	-	33.69	20.92
Grand Total (A+B)	6,802.63	3,313.96	161.33	9,955.26	3,138.45	647.72	138.32	3,647.85	75.52	-	-	75.52	6,231.90	3,588.66
Previous year	6,212.49	745.75	155.61	6,802.63	2,666.77	586.24	114.56	3,138.45	-	75.52	-	75.52	3,588.66	3,545.72
C. Capital work-in-progress													1,443.60	1,024.97
D. Intangible assets: under development													3.14	4.84

*Leasehold land represents one time lease rental paid for 99 years. Amortization of leasehold land rent of ₹2.85 million is capitalised/included in capital work-in-progress as part of pre-operative expenses.

At the top of the note you can see the Gross Block, Depreciation/amortization, and Net block being highlighted. I have also highlighted two net block numbers which tallies with what was mentioned in the balance sheet.

Let us look at a few more interesting aspects on this note. Notice under Tangible assets you can see the list of all the assets the company owns.

NOTE 10: FIXED ASSETS & DEPRECIATION

₹ million

Particulars	GROSS BLOCK				DEPRECIATION / AMORTISATION				IMPAIRMENT			NET BLOCK		
	As at March 31, 2013	Additions during the year	Deductions during the year	As at March 31, 2014	Upto March 31, 2013	For the year	On Deductions	Upto March 31, 2014	Upto March 31, 2013	For the year	On Deductions	Upto March 31, 2014	As at March 31, 2014	As at March 31, 2013
A. Tangible assets														
Land and land development														
- Freehold land	170.17	-	-	170.17	-	-	-	-	75.52	-	-	75.52	94.65	94.65
- Leasehold land*	133.65	267.86	-	401.51	0.84	2.22	-	3.06	-	-	-	-	398.45	132.81
Buildings	934.48	858.44	6.68	1,786.24	172.70	28.42	3.76	197.36	-	-	-	-	1,588.88	761.78
R&D buildings	9.90	9.03	-	18.93	4.59	0.48	-	5.07	-	-	-	-	13.86	5.31
Plant & machinery	4,549.43	1,950.56	121.13	6,378.86	2,527.37	522.95	105.11	2,945.21	-	-	-	-	3,433.65	2,022.06
R&D plant & machinery	118.84	36.85	9.75	145.94	81.90	12.84	8.95	85.79	-	-	-	-	60.15	36.94
Electrical installations	468.15	58.55	4.52	522.18	153.50	31.08	4.24	180.34	-	-	-	-	341.84	314.65
Furniture	79.25	21.56	0.002	100.81	42.45	4.87	0.002	47.32	-	-	-	-	53.49	36.80
Vehicles	105.50	37.65	12.54	130.61	33.81	9.73	10.07	33.47	-	-	-	-	97.14	71.69
Office equipment	181.06	63.16	6.71	237.51	102.78	24.09	6.19	120.68	-	-	-	-	116.83	78.28
Total	6,750.43	3,303.66	161.33	9,892.76	3,119.94	636.68	138.32	3,618.30	75.52	-	-	75.52	6,198.94	3,554.97
Previous year	6,181.26	724.78	155.61	6,750.43	2,656.46	578.04	114.56	3,119.94	-	75.52	-	75.52	3,554.97	3,524.80
B. Intangible assets														
Brands/trademarks	0.12	-	-	0.12	0.12	-	-	0.12	-	-	-	-	-	-
Computer software	52.08	10.30	-	62.38	18.39	11.04	-	29.43	-	-	-	-	32.96	33.69
Total	52.20	10.30	-	62.50	18.51	11.04	-	29.55	-	-	-	-	32.96	33.69
Previous year	31.23	20.97	-	52.20	10.31	8.20	-	18.51	-	-	-	-	33.69	20.92
Grand Total (A+B)	6,802.63	3,313.96	161.33	9,955.26	3,138.45	647.72	138.32	3,647.85	75.52	-	-	75.52	6,231.90	3,588.66
Previous year	6,212.49	745.75	155.61	6,802.63	2,666.77	586.24	114.56	3,138.45	-	75.52	-	75.52	3,588.66	3,545.72
C. Capital work-in-progress													1,443.60	1,024.97
D. Intangible assets under development													3.14	4.84

*Leasehold land represents one time lease rental paid for 99 years. Amortization of leasehold land rent of ₹2.85 million is capitalised/included in capital work-in-progress as part of pre-operative expenses.

For example, the company has listed 'Buildings' as one of its tangible asset. I have highlighted this part:-

NOTE 10: FIXED ASSETS & DEPRECIATION

₹ million

Particulars	GROSS BLOCK				DEPRECIATION / AMORTISATION				IMPAIRMENT			NET BLOCK		
	As at March 31, 2013	Additions during the year	Deductions during the year	As at March 31, 2014	Upto March 31, 2013	For the year	On Deductions	Upto March 31, 2014	Upto March 31, 2013	For the year	On Deductions	Upto March 31, 2014	As at March 31, 2014	As at March 31, 2013
A. Tangible assets														
Land and land development														
- Freehold land	170.17	-	-	170.17	-	-	-	-	75.52	-	-	75.52	94.65	94.65
- Leasehold land*	133.65	267.86	-	401.51	0.84	2.22	-	3.06	-	-	-	-	398.45	132.81
Buildings	934.48	858.44	6.68	1,786.24	172.70	28.42	3.76	197.36	-	-	-	-	1,588.88	761.78
R&D buildings	9.90	9.03	-	18.93	4.59	0.48	-	5.07	-	-	-	-	13.86	5.31
Plant & machinery	4,549.43	1,950.56	121.13	6,378.86	2,527.37	522.95	105.11	2,945.21	-	-	-	-	3,433.65	2,022.06
R&D plant & machinery	118.84	36.85	9.75	145.94	81.90	12.84	8.95	85.79	-	-	-	-	60.15	36.94
Electrical installations	468.15	58.55	4.52	522.18	153.50	31.08	4.24	180.34	-	-	-	-	341.84	314.65
Furniture	79.25	21.56	0.002	100.81	42.45	4.87	0.002	47.32	-	-	-	-	53.49	36.80
Vehicles	105.50	37.65	12.54	130.61	33.81	9.73	10.07	33.47	-	-	-	-	97.14	71.69
Office equipment	181.06	63.16	6.71	237.51	102.78	24.09	6.19	120.68	-	-	-	-	116.83	78.28
Total	6,750.43	3,303.66	161.33	9,892.76	3,119.94	636.68	138.32	3,618.30	75.52	-	-	75.52	6,198.94	3,554.97
Previous year	6,181.26	724.78	155.61	6,750.43	2,656.46	578.04	114.56	3,119.94	-	75.52	-	75.52	3,554.97	3,524.80
B. Intangible assets														
Brands/trademarks	0.12	-	-	0.12	0.12	-	-	0.12	-	-	-	-	-	-
Computer software	52.08	10.30	-	62.38	18.39	11.04	-	29.43	-	-	-	-	32.96	33.69
Total	52.20	10.30	-	62.50	18.51	11.04	-	29.55	-	-	-	-	32.96	33.69
Previous year	31.23	20.97	-	52.20	10.31	8.20	-	18.51	-	-	-	-	33.69	20.92
Grand Total (A+B)	6,802.63	3,313.96	161.33	9,955.26	3,138.45	647.72	138.32	3,647.85	75.52	-	-	75.52	6,231.90	3,588.66
Previous year	6,212.49	745.75	155.61	6,802.63	2,666.77	586.24	114.56	3,138.45	-	75.52	-	75.52	3,588.66	3,545.72
C. Capital work-in-progress													1,443.60	1,024.97
D. Intangible assets under development													3.14	4.84

*Leasehold land represents one time lease rental paid for 99 years. Amortization of leasehold land rent of ₹2.85 million is capitalised/included in capital work-in-progress as part of pre-operative expenses.

As of 31st March 2013 (FY13) ARBL reported the value of the building at Rs.93.4 Crs. During the FY14 the company added Rs.85.8Crs worth of building, this amount is classified as 'additions during the year'. Further they also wound up 0.668 Crs worth of building; this amount is classified as 'deductions during the year'. Hence the current year value of the building would be:

Previous year's value of building + addition during this year - deduction during the year

$$93.4 + 85.8 - 0.668 = 178.5 \text{ Crs}$$

You can notice this number being highlighted in blue in the above image. Do remember this is the gross block of the building. From the gross block one needs to deduct the accumulated depreciation to arrive at the 'Net Block'. In the snapshot below, I have highlighted the depreciation section belonging to the 'Building'.

NOTE 10: FIXED ASSETS & DEPRECIATION

₹ million

Particulars	GROSS BLOCK				DEPRECIATION / AMORTISATION				IMPAIRMENT				NET BLOCK	
	As at March 31, 2013	Additions during the year	Deductions during the year	As at March 31, 2014	Upto March 31, 2013	For the year	On Deductions	Upto March 31, 2014	Upto March 31, 2013	For the year	On Deductions	Upto March 31, 2014	As at March 31, 2014	As at March 31, 2013
A. Tangible assets														
Land and land development														
- Freehold land	170.17	-	-	170.17	-	-	-	-	75.52	-	-	75.52	94.65	94.65
- Leasehold land*	133.65	267.86	-	401.51	0.84	2.72	-	3.06	-	-	-	398.45	132.81	132.81
Buildings	934.48	858.44	6.68	1,786.24	172.70	28.42	3.76	197.38	-	-	-	1,588.88	761.78	761.78
R&D buildings	9.90	9.03	-	18.93	4.59	0.48	-	5.07	-	-	-	13.98	5.31	5.31
Plant & machinery	4,549.43	1,950.56	121.13	6,378.86	2,527.37	522.95	105.11	2,945.21	-	-	-	3,433.65	2,022.06	2,022.06
R&D plant & machinery	118.84	36.85	9.75	145.94	81.90	12.84	8.95	85.79	-	-	-	60.15	36.94	36.94
Electrical installations	468.15	58.55	4.52	522.18	153.50	31.08	4.24	180.34	-	-	-	341.84	314.65	314.65
Furniture	79.25	21.56	0.002	100.81	42.45	4.87	0.002	47.32	-	-	-	53.49	36.80	36.80
Vehicles	105.50	37.65	12.54	130.61	33.81	9.73	10.07	33.47	-	-	-	97.14	71.69	71.69
Office equipment	181.06	63.16	6.71	237.51	102.78	24.09	6.19	120.68	-	-	-	116.83	78.28	78.28
Total	6,750.43	3,303.66	161.33	9,892.76	3,119.94	636.68	138.32	3,618.30	75.52	-	-	6,198.94	3,554.97	3,554.97
Previous year	6,181.26	724.78	155.61	6,750.43	2,656.46	578.04	114.56	3,119.94	-	75.52	-	75.52	3,554.97	3,524.80
B. Intangible assets														
Brands/trademarks	0.12	-	-	0.12	0.12	-	-	0.12	-	-	-	-	-	-
Computer software	52.08	10.30	-	62.38	18.39	11.04	-	29.43	-	-	-	32.96	33.69	33.69
Total	52.20	10.30	-	62.50	18.51	11.04	-	29.55	-	-	-	32.96	33.69	33.69
Previous year	31.23	20.97	-	52.20	10.31	8.20	-	18.51	-	-	-	33.69	20.92	20.92
Grand Total (A+B)	6,802.63	3,313.96	161.33	9,955.26	3,138.45	647.72	138.32	3,647.85	75.52	-	-	6,231.90	3,588.66	3,588.66
Previous year	6,212.49	745.75	155.61	6,802.63	2,666.77	586.24	114.56	3,138.45	-	75.52	-	75.52	3,588.66	3,545.72
C. Capital work-in-progress														
D. Intangible assets under development														

*Leasehold land represents one time lease rental paid for 99 years. Amortisation of leasehold land rent of ₹2.85 million is capitalised/included in capital work-in-progress as part of pre-operative expenses.

As of 31st March 2013 (FY13) ARBL has depreciated Rs.17.2 Crs, to which they need to add Rs.2.8 Crs belonging to the year FY14, adjust 0.376 Crs as the deduction for the year. Thus, the Total Depreciation for the year is:-

Previous year's depreciation value + Current year's depreciation - Deduction for the year

$$= 17.2 + 2.8 - 0.376$$

Total Depreciation= Rs.19.736 Crs. This is highlighted in red in the image above.

So, we have building gross block at Rs.178.6 Crs and depreciation at Rs.19.73 Crs which gives us a net block of Rs.158.8 Crs (178.6- 19.73). The same has been highlighted in the image below:

NOTE 10: FIXED ASSETS & DEPRECIATION

₹ million

Particulars	GROSS BLOCK				DEPRECIATION / AMORTISATION				IMPAIRMENT			NET BLOCK		
	As at March 31, 2013	Additions during the year	Deductions during the year	As at March 31, 2014	Upto March 31, 2013	For the year	On Deductions	Upto March 31, 2014	Upto March 31, 2013	For the year	On Deductions	Upto March 31, 2014	As at March 31, 2014	As at March 31, 2013
A. Tangible assets														
Land and land development														
- Freehold land	170.17	-	-	170.17	-	-	-	-	75.52	-	-	75.52	94.65	94.65
- Leasehold land*	133.65	267.86	-	401.51	0.84	2.22	-	3.06	-	-	-	398.45	132.81	
Buildings	934.48	858.44	6.68	1,786.24	172.70	28.42	3.76	197.36	-	-	-	1,588.88	761.78	
R&D buildings	9.90	9.03	-	18.93	4.59	0.48	-	5.07	-	-	-	13.86	5.31	
Plant & machinery	4,549.43	1,950.56	121.13	6,378.86	2,527.37	522.95	105.11	2,945.21	-	-	-	3,433.65	2,022.06	
R&D plant & machinery	118.84	36.85	9.75	145.94	81.90	12.84	8.95	85.79	-	-	-	60.15	36.94	
Electrical installations	468.15	58.55	4.52	522.18	153.50	31.08	4.24	180.34	-	-	-	341.84	314.65	
Furniture	79.25	21.56	0.002	100.81	42.45	4.87	0.002	47.32	-	-	-	53.49	36.80	
Vehicles	105.50	37.65	12.54	130.61	33.81	9.73	10.07	33.47	-	-	-	97.14	71.69	
Office equipment	181.06	63.16	6.71	237.51	102.78	24.09	6.19	120.68	-	-	-	116.83	78.28	
Total	6,750.43	3,303.66	161.33	9,892.76	3,119.94	636.68	138.32	3,618.30	75.52	-	-	6,198.94	3,554.97	
Previous year	6,181.26	724.78	155.61	6,750.43	2,656.46	578.04	114.56	3,119.94	-	75.52	-	3,554.97	3,524.80	
B. Intangible assets														
Brands/trademarks	0.12	-	-	0.12	0.12	-	-	0.12	-	-	-	-	-	-
Computer software	52.08	10.30	-	62.38	18.39	11.04	-	29.43	-	-	-	32.96	33.69	
Total	52.20	10.30	-	62.50	18.51	11.04	-	29.55	-	-	-	32.96	33.69	
Previous year	31.23	20.97	-	52.20	10.31	8.20	-	18.51	-	-	-	33.69	20.92	
Grand Total (A+B)	6,802.63	3,313.96	161.33	9,955.26	3,138.45	647.72	138.32	3,647.85	75.52	-	-	6,231.90	3,588.66	
Previous year	6,212.49	745.75	155.61	6,802.63	2,666.77	586.24	114.56	3,138.45	-	75.52	-	3,588.66	3,545.72	
C. Capital work-in-progress												1,443.60	1,024.97	
D. Intangible assets under development												3.14	4.84	

*Leasehold land represents one time lease rental paid for 99 years. Amortization of leasehold land rent of ₹1.85 million is capitalised/included in capital work-in-progress as part of pre-operative expenses.

The same exercise is carried out for all the other tangible and intangible assets to arrive at the Total Net block number.

The next two line items under the fixed assets are Capital work in progress (CWIP) and Intangible assets under development.

CWIP includes building under construction, machinery under assembly etc at the time of preparing the balance sheet. Hence it is aptly called the "Capital Work in Progress". This amount is usually mentioned in the Net block section. CWIP is the work that is not yet complete but where a capital expenditure has already been incurred. As we can see, ARBL has Rs.144.3 Crs under CWIP. Once the construction process is done and the asset is put to use, the asset is moved to tangible assets (under fixed assets) from CWIP.

The last line item is 'Intangible assets under development'. This is similar to CWIP but for intangible assets. The work in process could be patent filing, copyright filing, brand development etc. This is at a miniscule cost of 0.3 Crs for ARBL. All these costs are added to arrive at the total fixed cost of the company.

7.3 – Non-current assets (Other line items)

Besides the fixed assets under the non-current assets, there are other line items as well. Here is a snapshot for the same:

Non-current investments	11	160.76		160.76
Long-term loans and advances	12	567.69		353.52
Other non-current assets	13	1.22		3.43

Non-current investments are investments made by ARBL with a long term perspective. This stands at Rs.16.07 Crs. The investment could be anything – buying

listed equity shares, minority stake in other companies, debentures, mutual funds etc. Here is the partial (as I could not fit the entire image) snapshot of Note 11. This should give you a perspective.

NOTE 11: NON-CURRENT INVESTMENTS		₹ million	
Particulars	As at March 31, 2014	As at March 31, 2013	
A. In Equity Instruments			
a. Quoted - Non trade at cost			
i) 125 Fully paid up equity shares of ₹1 each in Standard Batteries Limited	0.01	0.01	
Less: Provision for diminution in value	0.01	0.01	
	-	-	
ii) 25 Fully paid up equity shares of ₹2 each in Nicco Corporation Limited	0.001	0.001	
iii) 10,000 Fully paid up equity shares of ₹1 each in Exide Industries Limited	0.04	0.04	
iv) 5,500 Fully paid up equity shares of ₹1 each in HBL Power Systems Limited	0.01	0.01	
v) 160,000 Fully paid up equity shares of ₹2 each in IVRCL Limited	0.21	0.21	
vi) 23,749 Fully paid up equity shares of ₹10 each in IDBI Bank Limited	1.01	1.01	
vii) 227,900 Fully paid up equity shares of ₹10 each in Andhra Bank	2.28	3.55	2.28
			3.55
b. Unquoted - Non trade at Cost			
i) 1,128 Fully paid up equity shares of ₹10 each in Indian Lead Limited	0.03	0.03	
Less: Provision for diminution in value	0.03	-	0.03
			-
c. Unquoted - Trade at Cost			
i) 1,206,000 Fully paid up equity shares of ₹10 each in Andhra Pradesh Gas Power Corporation Limited		157.14	157.14
B. In Government Securities - Non trade at Cost			
a) 6 years National Savings Certificates (Lodged as security with Government departments.			

The next line item is long term loans and advances which stand at Rs.56.7Cr. These are loans and advances given out by the company to other group companies, employees, suppliers, vendors etc.

The last line item under the Non-current assets is 'Other Non-current assets' which is at Rs. 0.122 Crs. This includes other miscellaneous long term assets.

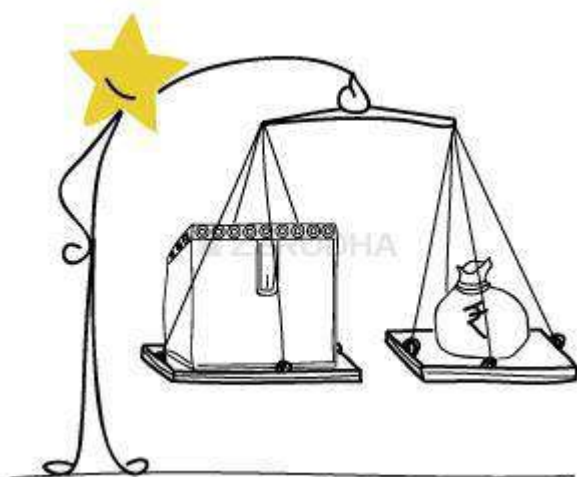

7.4 – Current assets

Current assets are assets that can be easily converted to cash and the company foresees a situation of consuming these assets within 365 days. Current assets are the assets that a company uses to fund its day to day operations and ongoing expenses.

The most common current assets are cash and cash equivalents, inventories, receivables, short term loans and advances and sundry debtors.

Here is the snapshot of the current assets of ARBL:

Current assets				
Inventories	14	3,350.08		2,928.58
Trade receivables	15	4,527.89		3,806.77
Cash and bank balances	16	2,945.67		4,107.90
Short-term loans and advances	12	2,119.30		1,656.78
Other current assets	13	43.16		68.49

The first line item on the Current assets is Inventory which stands at Rs.335.0 Crs. Inventory includes all the finished goods manufactured by the company, raw materials in stock, goods that are manufactured incompletely etc. Inventories are goods at various stages of production and hence have not been sold. When any product is manufactured in a company it goes through various processes from raw material, to work in progress to a finished good. Snapshot of Note 14 associated with inventory of the company is as shown below:

NOTE 14: INVENTORIES		₹ million	
Particulars	As at March 31, 2014	As at March 31, 2013	
(Valued at lower of cost or net realisable value)			
Raw materials	826.36		666.18
Add: Raw materials in transit	120.73		264.64
Total Raw materials		947.09	930.82
Work-in-process		1,052.11	828.95
Finished goods		941.75	536.44
Stock-in-trade		74.56	368.98
Stores and spares		323.27	255.22
Loose tools		6.07	4.39
Secondary packing materials and others		5.23	3.78
Total		3,350.08	2,928.58

As you can see, a bulk of the inventory value comes from 'Raw material' and 'Work-in- progress'.

The next line item is 'Trade Receivables' also referred to as 'Accounts Receivables'. This represents the amount of money that the company is expected to receive from its distributors, customers and other related parties. The trade receivable for ARBL stands at Rs.452.7 Crs.

The next line item is the Cash and Cash equivalents, which are considered the most liquid assets found in the Balance sheet of any company. Cash comprises of cash on

hand and cash on demand. Cash equivalents are short term, highly liquid investments which has a maturity date of less than three months from its acquisition date. This stands at Rs.294.5 Crs. Note 16 associated with Cash and bank balances is as shown below. As you can see the company has cash parked in various types of accounts.

NOTE 16: CASH AND BANK BALANCES		₹ million	
Particulars	As at March 31, 2014	As at March 31, 2013	
a) Cash and cash equivalents			
i) Balances with banks			
in current accounts	156.95	238.37	
in deposit accounts	2,445.79	3,652.00	
in exchange earner's foreign currency account	56.65	30.23	
ii) Cheques/drafts on hand	268.15	172.61	
iii) Cash on hand	1.09	1.47	4,094.68
b) Other bank balances in earmarked accounts			
Unclaimed dividends		17.04	13.22
Total		2,945.67	4,107.90

The next line item is short-term loans and advances, that the company has tendered and which is expected to be repaid back to the company within 365 days. It includes various items such as advances to suppliers, loans to customers, loans to employees, advance tax payments (income tax, wealth tax) etc. This stands at Rs.211.9 Crs. Following this, is the last line item on the Assets side and infact on the Balance sheet itself. This is the 'Other current assets' which are not considered important, hence termed 'Other'. This stands at Rs.4.3 Crs.

To sum up, the Total Assets of the company would now be:-

Fixed Assets + Current Assets

= Rs.840.831 Crs + Rs.1298.61 Crs

= Rs. 2139.441 Crs, which is exactly equal to the liabilities of the company.

With this we have now run through the entire Assets side of the Balance sheet, and infact the whole of Balance sheet itself. Let us relook at the balance sheet in its entirety:

Balance Sheet as at March 31, 2014

₹ million

Particulars	Note No.	As at March 31, 2014	As at March 31, 2013
EQUITY AND LIABILITIES			
Shareholders' funds			
Share capital	2	170.81	170.81
Reserves and surplus	3	13,456.20	10,427.33
		13,627.01	10,598.14
Non-current liabilities			
Long-term borrowings	4	759.47	773.13
Deferred tax liabilities (net)	5	301.33	195.09
Long-term provisions	6	369.57	376.41
		1,430.37	1,344.63
Current liabilities			
Short-term borrowings	7	83.83	98.63
Trade payables	8	1,277.79	1,362.84
Other current liabilities	9	2,156.68	1,807.26
Short-term provisions	6	2,818.73	2,493.20
		6,337.03	5,761.93
Total		21,394.41	17,704.70
ASSETS			
Non-current assets			
Fixed assets			
Tangible assets			
Tangible assets	10	6,198.94	3,554.97
Intangible assets		32.96	33.69
Capital work-in-progress		1,443.60	1,024.97
Intangible assets under development		3.14	4.84
		7,678.64	4,618.47
Non-current investments	11	160.76	160.76
Long-term loans and advances	12	567.69	353.52
Other non-current assets	13	1.22	3.43
		8,408.31	5,136.18
Current assets			
Inventories	14	3,350.08	2,928.58
Trade receivables	15	4,527.89	3,806.77
Cash and bank balances	16	2,945.67	4,107.90
Short-term loans and advances	12	2,119.30	1,656.78
Other current assets	13	43.16	68.49
		12,986.10	12,568.52
Total		21,394.41	17,704.70
Significant accounting policies	1		

Statement on significant accounting policies and notes are an integral part of the financial statements

As you can see in the above, the balance sheet equation holds true for ARBL's balance sheet,

$$\text{Asset} = \text{Shareholders' Funds} + \text{Liabilities}$$

Do remember, over the last few chapters we have only inspected the balance sheet and the P&L statements. However, we have not analyzed the data to infer if the numbers are good or bad. We will do the same when we look into the financial ratio analysis chapter.

In the next chapter, we will look into the last financial statement which is the cash flow statement. However, before we conclude this chapter we must look into the many ways the Balance sheet and the P&L statement are interconnected.

7.5 – Connecting the P&L and Balance Sheet

Let us now focus on the Balance Sheet and the P&L statement and the multiple ways they are connected (or affect) to each other.

Have a look at the following image:

Connecting the P&L and Balance Sheet

The P&L Statement		The Balance Sheet statement
Sales Revenue	---->	Receivables and Cash Balance
Operating Expenses	---->	Inventory and Trade Payables
Depreciation & Amortization	---->	Accumulated Depreciation
Other Income	---->	Investments
Finance Cost	---->	Debt
PAT	---->	Shareholders Equity

In the image above, on the left hand side we have the line items on a typical standard P&L statement. Corresponding to that on the right hand side we have some of the standard Balance Sheet items. From the previous chapters, you already know what each of these line items mean. However, we will now understand how the line items in the P&L and the Balance Sheet are connected to each other.

To begin with, consider the **Revenue from Sales**. When a company makes a sale it incurs expenses. For example if the company undertakes an advertisement campaign to spread awareness about its products, then naturally the company has to **spend cash** on the campaign. The money spent tends to decrease the cash balance. Also, if the company makes a sale on credit, the **Receivables** (Accounts Receivables) go higher.

Operating expenses includes purchase of raw material, finished goods and other similar expenses. When a company incurs these expenses, to manufacture goods two things happen. One, if the purchase is on credit (which invariably is) then the **Trade payables** (accounts payable) go higher. Two, the **Inventory** level also gets affected. Whether the inventory value is high or low, depends on how much time the company needs to sell its products.

When companies purchase Tangible assets or invest in Brand building exercises (Intangible assets) the company spreads the purchase value of the asset over the economic useful life of the asset. This tends to increase the **depreciation** mentioned in the Balance sheet. Do remember the Balance sheet is prepared on a flow basis, hence the Depreciation in balance sheet is accumulated year on year. Please note, Depreciation in Balance sheet is referred to as the **Accumulated depreciation**.

Other income includes monies received in the form of interest income, sale of subsidiary companies, rental income etc. Hence, when companies undertake **investment** activities, the other incomes tend to get affected.

As and when the company undertakes **Debt** (it could be short term or long term), the company obviously spends money towards financing the debt. The money that goes towards financing the debt is called the **Finance Cost/Borrowing Cost**. Hence, when debt increases the finance cost also increases and vice versa.

Finally, as you may recall the **Profit after tax (PAT)** adds to the surplus of the company which is a part of the **Shareholders equity**.

Key takeaways from this chapter

1. The Assets side of the Balance sheet displays all the assets the company owns
2. Assets are expected to give an economic benefit during its useful life
3. Assets are classified as Non-current and Current asset
4. The useful life of Non-current assets is expected to last beyond 365 days or 12 months
5. Current assets are expected to payoff within 365 days or 12 months
6. Assets inclusive of depreciation are called the 'Gross Block'
7. $\text{Net Block} = \text{Gross Block} - \text{Accumulated Depreciation}$
8. The sum of all assets should equal the sum of all liabilities. Only then the Balance sheet is said to have balanced.
9. The Balance sheet and P&L statement are inseparable. They are connected to each other in many ways.

The Cash Flow statement

8.1 – Overview

The Cash flow statement is a very important financial statement, as it reveals how much cash the company is actually generating. Is this information not revealed in the P&L statement you may think? Well, the answer is both a yes and a no.

Consider the following scenario.

Assume a simple coffee shop selling coffee and short eats. All the sales the shop does is mostly on cash basis, meaning if a customer wants to have a cup of coffee and a snack, he needs to have enough money to buy what he wants. Going by that on a particular day, assume the shop manages to sell Rs.2,500/- worth of coffee and Rs.3,000/- worth of snacks. It is evident that the shop's income is Rs.5,500/- for that day. Rs.5,500/- is reported as revenues in P&L, and there is no ambiguity with this.

Now think about another business that sells laptops. For sake of simplicity, let us assume that the shop sells only 1 type of laptop at a standard fixed rate of Rs.25,000/- per laptop. Assume on a certain day, the shop manages to sell 20 such laptops. Clearly the revenue for the shop would be $\text{Rs.}25,000 \times 20 = \text{Rs.}500,000/-$. But what if 5 of the 20 laptops were sold on credit? A credit sale is when the customer takes the product today but pays the cash at a later point in time. In this situation here is how the numbers would look:

Cash sale: $15 * 25000 = \text{Rs.}375,000/-$

Credit sale: $5 * 25000 = \text{Rs.}125,000/-$

Total sales: Rs.500,000/-

If this shop was to show its total revenue in its P&L statement, you would just see a revenue of Rs.500,000/- which may seem good on the face of it. However, how much of this Rs.500,000/- is actually present in the company's bank account is not clear. What if this company had a loan of Rs.400,000/- that had to be repaid back urgently? Even though the company has a sale of Rs.500,000 it has only Rs.375,000/- in its account. This means the company has a cash crunch, as it cannot meet its debt obligations.

The cash flow statement captures this information. A statement of cash flows should be presented as an integral part of an entity's financial statements. Hence in

this context evaluation of the cash flow statement is highly critical as it reveals amongst other things, the true cash position of the company.

To sum up, every company's financial performance is not so much dependent on the profits earned during a period, but more realistically on liquidity or cash flows.



8.2 – Activities of a company

Before we go ahead to understand the cash flow statement, it is important to understand 'the activities' of a company. If you think about a company and the various business activities it undertakes, you will realize that the company's activities can be classified under one of the three standard baskets. We will understand this in terms of an example.

Imagine a business, maybe a very well established fitness center (Talwalkars, Gold's Gym etc) with a sound corporate structure. What are the typical business activities you think a fitness center would have? Let me go ahead and list a few business activities:

1. Display advertisements to attract new customers
2. Hire fitness instructors to help clients in their fitness workout
3. Buy new fitness equipments to replace worn out equipments
4. Seek short term loan from bankers
5. Issue a certificate of deposit for raising funds
6. Issue new shares to a few known friends to raise fresh capital for expansion (also called preferential allotment)
7. Invest in a startup company working towards innovative fitness regimes
8. Park excess money (if any) in fixed deposits
9. Invest in a building coming up in the neighborhood, for opening a new fitness center sometime in the future
10. Upgrade the sound system for a better workout experience

As you can see the above listed business activities are quite diverse however they are all related to the business. We can classify these activities as:

1. **Operational activities (OA):** Activities that are directly related to the daily core business operations are called operational activities. Typical operating activities include sales, marketing, manufacturing, technology upgrade, resource hiring etc.
2. **Investing activities (IA):** Activities pertaining to investments that the company makes with an intention of reaping benefits at a later stage. Examples include parking money in interest bearing instruments, investing in equity shares, investing in land, property, plant and equipment, intangibles and other non current assets etc
3. **Financing activities (FA):** Activities pertaining to all financial transactions of the company such as distributing dividends, paying interest to service debt, raising fresh debt, issuing corporate bonds etc

All activities a legitimate company performs can be classified under one of the above three mentioned categories.

Keeping the above three activities in perspective, we will now classify each of the above mentioned activities into one of the three categories /baskets.

1. Display advertisements to attract new customers – OA
2. Hire fitness instructors to help customers with their fitness workout – OA
3. Buy new fitness equipment to replace worn out equipments – OA
4. Seek a short term loan from bankers – FA
5. Issue a certificate of deposit (CD) for raising funds – FA
6. Issue new shares to few known friends to raise fresh capital for expansion (also called preferential allotment) – FA
7. Invest in a startup company working towards innovative fitness regimes – IA
8. Park excess money (if any) in fixed deposit – IA
9. Invest in a building coming up in the neighborhood for opening a new fitness center sometime in the future – IA
10. Upgrade the sound system for better workout experience- OA

Now think about the cash moving in and out of the company and its impact on the cash balance. Each activity that the company undertakes has an impact on cash. For example “Upgrade the sound system for a better workout experience” means the company has to pay money towards the purchase of a new sound system, hence the cash balance decreases. Also, it is interesting to note that the new sound system itself will be treated as a company asset.

Keeping this in perspective, we will now understand for the example given above how the various activities listed would impact the cash balance and how would it impact the balance sheet.

Activity No	Activity Type	Rational	Cash Balance	On Balance Sheet
01	OA	Expenditure towards advertisement	Decreases	Treated as an asset as it increases the brand value
02	OA	Expenditure towards new recruits	Decreases	Treated as an asset as it increases the company's intellectual capital
03	OA	Expenditure towards new equipment	Decreases	Treated as asset
04	FA	Loan means cash inflow to business	Increases	Loan is a liability
05	FA	Deposits via CD means cash inflow	Increases	CD is a liability
06	FA	Issue of fresh capital means cash inflow	Increases	Treated as a liability as share capital increases
07	IA	Investment in startup means cash outflow	Decreases	Investment is an asset
08	IA	Money parked in FD means cash going out of business	Decreases	Equivalent to cash, hence considered an asset
09	IA	Investment in building means cash going out of business	Decreases	Gross block considered an asset
10	OA	Expenditure towards the sound system	Decreases	Treated as an asset

The table above is colour coded:

1. Increase in cash is colour coded in blue
2. Decrease in cash is colour coded in red
3. Assets are colour coded in green and
4. Liabilities are colour coded in purple.

If you look through the table and start correlating the 'Cash Balance' and 'Asset/Liability' you will observe that:

1. Whenever the liabilities of the company increases the cash balance also increases
1. This means if the liabilities decreases, the cash balance also decreases
2. Whenever the asset of the company increases, the cash balance decreases
1. This means if the assets decreases, the cash balance increases

The above conclusion is the key concept while constructing a cash flow statement. Also, extending this further you will realize that each activity of the company be it operating activity, financing activity, or investing activity either produces cash (net increase in cash) or reduces (net decrease in cash) the cash for the company.

Hence the total cash flow for the company will be:-

$$\text{Cash Flow of the company} = \text{Net cash flow from operating activities} + \text{Net Cash flow from investing activities} + \text{Net cash flow from financing activities}$$

8.3 – The Cash Flow Statement

Having some insight into the cash flow statement, you would now appreciate the fact that you need to look into the cash flow statement to review the company from a cash perspective.

Typically when companies present their cash flow statement they split the statement into three segments to explicitly show how much cash the company has generated across the three business activities. Continuing with our example from the earlier chapters, here is the cash flow statement of Amara Raja Batteries Limited (ARBL):

Particulars	Year ended March 31, 2014		Year ended March 31, 2013	
I. CASH FLOW FROM OPERATING ACTIVITIES				
Profit before tax from continuing operations		5,366.70		4,218.17
Add/(Less): Adjustments for				
a. Depreciation	636.69		577.20	
b. Amortisation	11.04		8.20	
c. Impairment loss	-		75.52	
d. Net income on sale of tangible fixed assets	(2.26)		(0.04)	
e. Tangible fixed assets written off	24.90		44.27	
f. Donation of tangible fixed asset	0.03		-	
g. Interest paid on working capital facilities	0.03		0.11	
h. Provisions and credit balances written back	(3.90)		(6.44)	
i. Bad debts written off	32.33		4.84	
j. Provision for doubtful trade receivables and advances (net)	(30.50)		(38.69)	
k. Exchange gain on restatement - other than borrowings (net)	(33.81)		(13.18)	
l. Provision for leave encashment	14.83		33.43	
m. Provision for gratuity	6.75		8.74	
n. Provision for warranty	(40.22)		156.14	
o. Dividend received	(144.19)		(145.27)	
p. Interest received on bank and other deposits	(137.94)		(112.29)	
q. Interest on income tax	6.70		2.03	
r. Provision for wealth tax	2.00	342.48	1.83	596.40
Operating profit before working capital changes		5,709.18		4,814.57
Add/(Less): Adjustments for working capital changes				
a. Increase in inventories	(421.50)		(262.41)	
b. Increase in trade receivables	(711.71)		(571.57)	
c. Increase in loans and advances	(445.72)		(421.49)	
d. Increase/(decrease) in trade payables	(77.73)		490.32	
e. Increase in other current liabilities	341.23	(1,315.43)	671.36	(93.79)
Cash generated from operations		4,393.75		4,720.78
Less: a. Income tax	1,604.42		1,365.95	
b. Wealth tax	1.83	1,606.25	0.18	1,366.13
Net cash from operating activities - A		2,787.50		3,354.65

I will skip going through each line item as most of them are self explanatory, however I want you to notice that ARBL has generated Rs.278.7 Crs from operating activities. Note, a company which has a positive cash flow from operating activities is always a sign of financial well being.

Here is the snapshot of ARBL's cash flow from investing activities:

II. CASH FLOW FROM INVESTING ACTIVITIES				
a. Purchase of tangible fixed assets		(3,303.66)		(724.78)
b. Purchase of intangible fixed assets		(10.30)		(20.97)
c. Increase in capital work-in-progress		(423.26)		(718.50)
d. Decrease/(increase) in intangible assets under development		1.69		(0.25)
e. Sale of tangible fixed assets		4.98		1.80
g. Interest received on bank and other deposits		137.94		112.29
h. Dividend received		144.19		145.27
Net cash from investing activities - B		(3,448.42)		(1,205.14)

As you can see, ARBL has consumed Rs.344.8 Crs in its investing activities. This is quite intuitive as investing activities tend to consume cash. Also remember healthy

investing activities foretells the investor that the company is serious about its business expansion. Of course how much is considered healthy and how much is not, is something we will understand as we proceed through this module.

Finally, here is the snapshot of ARBL's cash balance from financing activities:

Particulars	Year ended March 31, 2014	Year ended March 31, 2013
III. CASH FLOW FROM FINANCING ACTIVITIES		
a. Short term borrowings from banks availed / repaid	(13.70)	42.59
b. Interest free sales tax deferment repaid	(13.67)	(16.92)
c. Interest paid on working capital facilities	(0.03)	(0.11)
d. Dividend paid	(430.45)	(322.84)
e. Dividend tax paid	(73.15)	(52.37)
Net cash from financing activities - C	(531.00)	(349.65)

ARBL consumed Rs.53.1Cr through its financing activities. If you notice the bulk of the money went in paying dividends. **Also, if ARBL takes on new debt in future it would lead to an increase in the cash balance** (remember increase in liabilities, increases cash balance). We know from the balance sheet that ARBL did not undertake any new debt.

Let us summarize the cash flow from all the activities:

Cash Flow from	Rupees Crores (2013-14)	Rupees Crores (2012-13)
Operating Activities	278.7	335.4
Investing Activities	(344.8)	(120.05)
Financing Activities	(53.1)	(34.96)
Total	(119.19)	179.986

This means the company consumed a total cash of Rs.119.19 Crs for the financial year 2013 -2014. Fair enough, but what about the cash from the previous year? As we can see, the company generated Rs.179.986 Crs through all its activities from the previous year. Here is an extract from ARBL's cash flow statement:

Opening cash and cash equivalents	4,094.68	2,283.19
Add: Net increase/(decrease) in cash and cash equivalents	(1,191.92)	1,799.86
Add: Effect of foreign exchange differences on restatement of cash and cash equivalents	25.87	11.63
Closing cash and cash equivalents	2,928.63	4,094.68

Look at the section highlighted in green (for the year 2013-14). It says the opening balance for the year is Rs.409.46Cr. How did they get this? Well, this happens to be the closing balance for the previous year (refer to the arrow marks). Add to this the current year's cash equivalents which is (Rs.119.19) Crs along with a minor forex exchange difference of Rs.2.58 Crs we get the total cash position of the company which is Rs.292.86 Crs. This means, while the company guzzled cash on a yearly basis, they still have adequate cash, thanks to the carry forward from the previous year.

Note, the closing balance of 2013-14 will now be the opening balance for the FY 2014 – 15. You can watch out for this when ARBL provides its cash flow numbers for the year ended 31st March 2015.

At this point, let us run through a few interesting questions and answers:

1. What does Rs.292.86 Crs actually state?
 1. This literally shows how much cash ARBL has in its various bank accounts
2. What is cash?
 1. Cash comprises cash on hand and demand deposits. Obviously, this is a liquid asset of the company
3. What are liquid assets?
 1. Liquid assets are assets that can be easily converted to cash or cash equivalents
4. Are liquid assets similar to 'current items' that we looked at in the Balance sheet?
 1. Yes, you can think of it that way
5. If cash is current and cash is an asset, shouldn't it reflect under the current asset on the Balance sheet?
 1. Exactly and here it is. Look at the balance sheet extract below.

ASSETS					
Non-current assets					
Fixed assets	10				
Tangible assets		6,198.94		3,554.97	
Intangible assets		32.96		33.69	
Capital work-in-progress		1,443.60		1,024.97	
Intangible assets under development		3.14		4.84	
		7,678.64		4,618.47	
Non-current investments	11	160.76		160.76	
Long-term loans and advances	12	567.69		353.52	
Other non-current assets	13	1.22		3.43	
			8,408.31		5,136.18
Current assets					
Inventories	14	3,350.08		2,928.58	
Trade receivables	15	4,527.89		3,806.77	
Cash and bank balances	16	2,945.67		4,107.90	
Short-term loans and advances	12	2,119.30		1,656.78	
Other current assets	13	43.16		68.49	
			12,986.10		12,568.52

Clearly, we can now infer that the cash flow statement and the balance sheet interact with each other. This is in line with what we had discussed earlier i.e all the three financial statements are interconnected with each other.

8.4 – A brief on the financial statements

Over the last few chapters we have discussed the three important financial statements of the company i.e the P&L statement, the Balance Sheet and the Cash Flow statement of the company. While the Cash flow and P&L statement are prepared on a standalone basis (representing the financial position for the given year), the Balance Sheet is prepared on a flow basis.

The P&L statement discusses how much the company earned as revenues versus how much the company expended in terms of expenses. The retained earnings of the company also called the surplus of the company are carried forward to the balance sheet. The P&L also incorporates the depreciation number. The depreciation mentioned in the P&L statement is carried forward to the balance sheet.

The Balance Sheet details the company's assets and liabilities. On the liabilities side of the Balance sheet the company represents the shareholders' funds. The assets should always be equal to the liabilities, only then do we say the balance sheet has balanced. One of the key details on the balance sheet is the cash and cash equivalents of the firm. This number tells us, how much money the company has in its bank account. This number comes from the cash flow statement.

The cash flow statement provides information to the users of the financial statements about the entity's ability to generate cash and cash equivalents as well as indicates the cash needs of a company. The statement of cash flows are prepared on a historical basis providing information about the cash and cash equivalents, classifying cash flows in to operating, financing and investing activities. The final number of the cash flow tells us how much money the company has in its bank account.

We have so far looked into how to read the financial statements and what to expect out of each one of them. We have not yet ventured into how to analyze these numbers. One of the ways to analyze the financial numbers is by calculating a few important financial ratios. In fact we will focus on the financial ratios in the next few chapters.

Key takeaways from this chapter

1. The Cash flow statement gives us a picture of the true cash position of the company
2. A legitimate company has three main activities – operating activities, investing activities and the financing activities
3. Each activity either generates or drains money for the company
4. The net cash flow for the company is the sum of operating activities, investing activities and the financing activities
5. Investors should specifically look at the cash flow from operating activities of the company
6. When the liabilities increase, cash level increases and vice versa
7. When the assets increase, cash level decreases and vice versa
8. The net cash flow number for the year is also reflected in the balance sheet
9. The Statement of Cash flow is a useful addition to the financial statements of a company because it indicates the company's performance.

The Financial Ratio Analysis (Part 1)

9.1 – A note on Financial Ratios

Over the last few chapters we have understood how to read the financial statements. We will now focus our attention on analyzing these financial statements. The best way to analyze the financial statements is by studying the 'Financial Ratios'. The theory of financial ratios was made popular by Benjamin Graham, who is popularly known as the father of fundamental analysis. Financial ratios help in interpreting the results, and allows comparison with previous years and other companies in the same industry.

A typical financial ratio utilizes data from the financial statement to compute its value. Before we start understanding the financial ratios, we need to be aware of certain attributes of the financial ratios.

On its own merit, the financial ratio of a company conveys very little information. For instance, assume Ultratech Cements Limited has a profit margin of 15%, how useful do you think this information is? Well, not much really. 15% profit margin is good, but how would I know if it is the best?

However, assume you figure out ACC Cement's profit margin is 12%. Now, as we comparing two similar companies, comparing the profitability makes sense. Clearly, Ultratech Cements Limited seems to be a more profitable company between the two. The point that I am trying to drive across is that more often than not, Financial Ratios on its own is quite mute. The ratio makes sense only when you compare the ratio with another company of a similar size or when you look into the trend of the financial ratio. This means that once the ratio is computed the ratio has to be analyzed (either by comparison or tracking the ratio's historical trend) to get the best possible inference.

Also, here is something that you need to be aware off while computing ratios. Accounting policies may vary across companies and across different financial years. A fundamental analyst should be cognizant of this fact and should adjust the data accordingly, before computing the financial ratio.

9.2 – The Financial Ratios

Financial ratios can be 'somewhat loosely' classified into different categories, namely –

1. Profitability Ratios
2. Leverage Ratios
3. Valuation Ratios
4. Operating Ratios



The Profitability ratios help the analyst measure the profitability of the company. The ratios convey how well the company is able to perform in terms of generating profits. Profitability of a company also signals the competitiveness of the management. As the profits are needed for business expansion and to pay dividends to its shareholders a company's profitability is an important consideration for the shareholders.

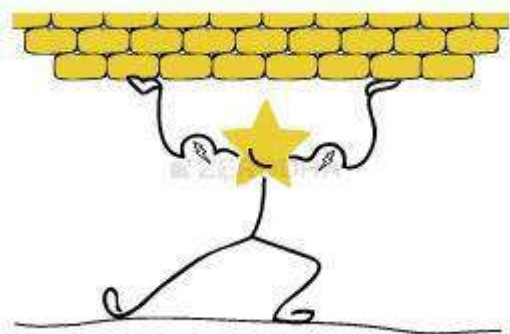

The Leverage ratios also referred to as solvency ratios/ gearing ratios measures the company's ability (in the long term) to sustain its day to day operations. Leverage ratios measure the extent to which the company uses the debt to finance growth. Remember for the company to sustain its operations, it has to pay its bills and obligations. Solvency ratios help us understand the company's long term sustainability, keeping its obligation in perspective.



The Valuation ratios compare the stock price of the company with either the profitability of the company or the overall value of company to get a sense of how cheap or expensive the stock is trading. Thus this ratio helps us in analysing whether the current share price of the company is perceived as high or low. In simpler words, the valuation ratio compares the cost of a security with the perks of owning the stock.



The Operating Ratios, also called the 'Activity Ratios' measures the efficiency at which a business can convert its assets (both current and noncurrent) into revenues. This ratio helps us understand how efficient the management of the company is. For this reason, Operating Ratios are sometimes called the 'Management Ratios'.

Strictly speaking, ratios (irrespective of the category it belongs to) convey a certain message, usually related to the financial position of the company. For example, 'Profitability Ratio' can convey the efficiency of the company, which is usually measured by computing the 'Operating Ratio'. Because of such overlaps, it is difficult to classify these ratios. Hence the ratios are 'somewhat loosely' classified.

9.3 – The Profitability Ratios

We will look into the following ratios under 'The Profitability Ratio':

1. EBITDA Margin (Operating Profit Margin)
 - EBITDA Growth (CAGR)
2. PAT Margin
 - PAT Growth (CAGR)

3. Return on Equity (ROE)
4. Return on Asset (ROA)
5. Return on Capital Employed (ROCE)

EBITDA Margin:

The Earnings before Interest Tax Depreciation & Amortization (EBITDA)

Margin indicates the efficiency of the management. It tells us how efficient the company's operating model is. EBITDA Margin tells us how profitable (in percentage terms) the company is at an operating level. It always makes sense to compare the EBITDA margin of the company versus its competitor to get a sense of the management's efficiency in terms of managing their expense.

In order to calculate the EBITDA Margin, we first need to calculate the EBITDA itself.

$$\text{EBITDA} = [\text{Operating Revenues} - \text{Operating Expense}]$$

$$\text{Operating Revenues} = [\text{Total Revenue} - \text{Other Income}]$$

$$\text{Operating Expense} = [\text{Total Expense} - \text{Finance Cost} - \text{Depreciation \& Amortization}]$$

$$\text{EBITDA Margin} = \text{EBITDA} / [\text{Total Revenue} - \text{Other Income}]$$

Continuing the example of Amara Raja Batteries Limited, the EBITDA Margin calculation for the FY14 is as follows:

We first calculate EBITDA , which is computed as follows:

$$[\text{Total Revenue} - \text{Other Income}] - [\text{Total Expense} - \text{Finance Cost} - \text{Depreciation \& Amortization}]$$

Note: Other income is income by virtue of investments and other non operational activity. Including other income in EBITDA calculation would clearly skew the data. For this reason, we have to exclude Other Income from Total Revenues.

$$[3482 - 46] - [2942 - 0.7 - 65]$$

$$= [3436] - [2876]$$

$$= \mathbf{560 \text{ Crores}}$$

Hence the EBITDA Margin is:

$$560 / 3436$$

$$= \mathbf{16.3\%}$$

I have two questions for you at this stage:

1. What does an EBITDA of Rs.560 Crs and an EBITDA margin of 16.3% indicate?
2. How good or bad an EBITDA margin of 16.3% is?

The first question is a fairly simple. An EBITDA of Rs.560 Crs means that the company has retained Rs.560 Crs from its operating revenue of Rs.3436 Crs. This also means out of Rs.3436 Crs the company spent Rs.2876 Crs towards its expenses. In percentage terms, the company spent 83.7% of its revenue towards its expenses and retained 16.3% of the revenue at the operating level, for its operations.

Now for the 2nd question, hopefully you should **not** have an answer.

Remember we did discuss this point earlier in this chapter. A financial ratio on its own conveys very little information. To make sense of it, we should either see the trend or compare it with its peers. Going with this, a 16.3% EBITDA margin conveys very little information.

To makes some sense of the EBITDA margin, let us look at Amara Raja's EBITDA margin trend for the last 4 years, (all numbers in Rs Crs, except EBITDA margin):

Year	Operating Revenues	Operating Expense	EBITDA	EBITDA Margin
2011	1761	1504	257	14.6%
2012	2364	2025	340	14.4%
2013	2959	2508	451	15.2%
2014	3437	2876	560	16.3%

It appears that ARBL has maintained its EBITDA at an average of 15%, and in fact on a closer look it is clear the EBITDA margin is increasing. This is a good sign as it shows consistency and efficiency in the management's operational capabilities.

In 2011 the EBITDA was Rs.257 Crs and in 2014 the EBITDA is Rs.560Crs. This translates to a 4 year **EBITDA CAGR growth** of 21%.

Please note, we have discussed the formula for CAGR in [module 1](#).

Clearly, it appears that both EBITDA margin and EBITDA growth are quite impressive. However we still do not know if it is the best. In order to find out if it is the best one needs to compare these numbers with its competitors. In case of ARBL

it would be Exide batteries Limited. I would encourage you to do the same for Exide and compare the results.

PAT Margin:

While the EBITDA margin is calculated at the operating level, the Profit After Tax (PAT) margin is calculated at the final profitability level. At the operating level we consider only the operating expenses however there are other expenses such as depreciation and finance costs which are not considered. Along with these expenses there are tax expenses as well. When we calculate the PAT margin, all expenses are deducted from the Total Revenues of the company to identify the overall profitability of the company.

PAT Margin = [PAT/Total Revenues]

PAT is explicitly stated in the Annual Report. ARBL's PAT for the FY14 is Rs.367 Crs on the overall revenue of Rs.3482 Crs (including other income). This translates to a PAT margin of:

$$= 367 / 3482$$

$$= 10.5 \%$$

Here is the PAT and PAT margin trend for ARBL:

Year	PAT (in INR Crs)	PAT Margin
2011	148	8.4%
2012	215	8.9%
2013	287	9.6%
2014	367	10.5%

The PAT and PAT margin trend seems impressive as we can clearly see a margin expansion. The 4 year CAGR growth stands at 25.48%, which is again good. Needless to say, it always makes sense to compare ratios with its competitors.

Return on Equity (RoE):

The Return on Equity (RoE) is a very important ratio, as it helps the investor assess the return the shareholder earns for every unit of capital invested. RoE measures the entity's ability to generate profits from the shareholders investments. In other words, RoE shows the efficiency of the company in terms of generating profits to its shareholders. Obviously, higher the RoE, the better it is for the shareholders. In fact this is one of the key ratios that helps the investor identify investable attributes of the company. To give you a perspective, the average RoE of top Indian companies vary between 14 – 16%. I personally prefer to invest in companies that have a RoE of 18% upwards.

This ratio is compared with the other companies in the same industry and is also observed over time.

Also note, if the RoE is high, it means a good amount of cash is being generated by the company, hence the need for external funds is less. Thus a higher ROE indicates a higher level of management performance.

RoE can be calculated as: [Net Profit / Shareholders Equity* 100]

There is no doubt that RoE is an important ratio to calculate, but like any other financial ratios it also has a few drawbacks. To help you understand its drawbacks, consider this hypothetical example.

Assume Vishal runs a Pizza store. To bake pizza's Vishal needs an oven which costs him Rs.10,000/-. Oven is an asset to Vishal's business. He procures the oven from his own funds and seeks no external debt. At this stage you would agree on his balance sheet he has a shareholder equity of Rs.10,000 and an asset equivalent to Rs.10,000.

Now, assume in his first year of operation, Vishal generates a profit of Rs.2500/-. What is his RoE? This is quite simple to compute:

$$\begin{aligned}\text{RoE} &= 2500/10000*100 \\ &=25.0\%.\end{aligned}$$

Now let us twist the story a bit. Vishal has only Rs.8000/- he borrows Rs.2000 from his father to purchase an oven worth Rs.10000/-. How do you think his balance sheet would look?

On the liability side he would have:

Shareholder Equity = Rs.8000

Debt = Rs.2000

This makes Vishal's total liability Rs. 10,000. Balancing this on the asset side, he has an asset worth Rs.10,000. Let us see how his RoE looks now:

$$\text{RoE} = 2500 / 8000 * 100$$

$$= 31.25\%$$

With an additional debt, the RoE shot up quite significantly. Now, what if Vishal had only Rs.5000 and borrowed the additional Rs.5000 from his father to buy the oven. His balance sheet would look like this:

On the liability side he would have:

Shareholder Equity = Rs.5000

Debt = Rs.5000

Vishal's total liability is Rs. 10,000. Balancing this on the asset side, he has an asset worth Rs.10,000. Let us see how his RoE looks now:

$$\text{RoE} = 2500 / 5000 * 100$$

$$= 50.0\%$$

Clearly, higher the debt Vishal seeks to finance his asset, (which in turn is required to generate profits) higher is the RoE. A high RoE is great, but certainly not at the cost of high debt. The problem is with a high amount of debt, running the business gets very risky as the finance cost increases drastically. For this reason inspecting the RoE closely becomes extremely important. One way to do this is by implementing a technique called the '**DuPont Model**' also called **DuPont Identity**.

This model was developed in 1920's by the DuPont Corporation. DuPont Model breaks up the RoE formula into three components with each part representing a certain aspect of business. The DuPont analysis uses both the P&L statement and the Balance sheet for the computation.

The RoE as per DuPont model can be calculated as:

Return on Equity =	$\frac{\text{Net Profit}}{\text{Net Sales}}$	x	$\frac{\text{Net Sales}}{\text{Avg Total Assets}}$	x	$\frac{\text{Avg Total Assets}}{\text{Shareholder Equity}}$
---------------------------	--	---	--	---	---

If you notice the above formula, the denominator and the numerator cancels out with one another eventually leaving us with the original RoE formula which is:

$$\text{RoE} = \text{Net Profit} / \text{Shareholder Equity} * 100$$

However in the process of decomposing the RoE formula, we gained insights into three distinct aspects of the business. Let us look into the three components of the DuPont model that makes up the RoE formula :

- **Net Profit Margin = Net Profits/ Net Sales*100**
This is the first part of the DuPont Model and it expresses the company's ability to generate profits. This is nothing but the PAT margin we looked at earlier in this chapter. A low Net profit margin would indicate higher costs and increased competition.
- **Asset Turnover = Net Sales / Average Total asset**
Asset turnover ratio is an efficiency ratio that indicates how efficiently the company is using its assets to generate revenue. Higher the ratio, it means the company is using its assets more efficiently. Lower the ratio, it could indicate management or production problems. The resulting figure is expressed as number of times per year.
- **Financial Leverage = Average Total Assets / Shareholders Equity**
Financial leverage helps us answer this question – 'For every unit of shareholders equity, how many units of assets does the company have'. For example if the financial leverage is 4, this means for every Rs.1 of equity, the company supports Rs.4 worth of assets. Higher the financial leverage along with increased amounts of debt, will indicate the company is highly leveraged and hence the investor should exercise caution. The resulting figure is expressed as number of times per year.
As you can see, the DuPont model breaks up the RoE formula into three distinct components, with each component giving an insight into the company's operating and financial capabilities.

Let us now proceed to implement the DuPont Model to calculate Amara Raja's RoE for the FY 14. For this we need to calculate the values of the individual components.

Net Profit Margin: As I mentioned earlier, this is same as the PAT margin. From our calculation earlier, we know the Net Profit Margin for ARBL is **9.2%**

Asset Turnover = Net Sales / Average Total assets

We know from the FY14 Annual Report, Net sales of ARBL stands at Rs.3437 Crs.

The denominator has Average Total Assets which we know can be sourced from the Balance Sheet. But what does the word 'Average' indicate?

From ARBL's balance sheet, the total asset for FY14 is Rs.2139Crs. But think about this, the reported number is for the Financial Year 2014, which starts from 1st of April 2013 and close on 31st March 2014. This implies that at the start of the financial year 2014 (1st April 2013), the company must have commenced its operation with assets that it carried forward from the previous financial year (FY 2013). During the financial year (FY 2014) the company has acquired some more assets which when added to the previous year's (FY2013) assets totaled to Rs.2139 Crs. Clearly the company started the financial year with a certain rupee value of assets but closed the year with a totally different rupee value of assets.

Keeping this in perspective, if I were to calculate the asset turnover ratio, which asset value should I consider for the denominator? Should I consider the asset value at the beginning of the year or at the asset value at the end of the year? To avoid confusion, the practice is to take average of the asset values for the two financial years.

Do remember this technique of averaging line items, as we will be using this across other ratios as well.

From ARBL's annual report we know:

Net Sales in FY14 is Rs.3437Crs

Total Assets in FY13 is Rs.1770 Crs

Total Assets in FY14 is Rs.2139 Crs

Average Assets = $(1770 + 2139) / 2$

= 1955

Asset Turnover = $3437 / 1955$

= **1.75 times**

This means for every Rs.1 of asset deployed, the company is generating Rs.1.75 in revenues.

We will now calculate the last component that is the Financial Leverage.

Financial Leverage = Average Total Assets / Average Shareholders Equity

We know the average total assets is Rs.1955. We just need to look into the shareholders equity. For reasons similar to taking the "Average Assets" as opposed to just the current year assets, we will consider "Average Shareholder equity" as opposed to just the current year's shareholder equity.

Shareholders Equity for FY13 = Rs.1059 Crs

Shareholders Equity for FY14 = Rs.1362 Crs

Average shareholder equity = Rs.1211 Crs

Financial Leverage = $1955 / 1211$

= **1.61 times**

Considering ARBL has little debt, Financial Leverage of 1.61 is indeed an encouraging number. The number above indicates that for every Rs.1 of Equity, ARBL supports Rs.1.61 of assets.

We now have all the inputs to calculate RoE for ARBL, we will now proceed to do the same:

RoE = Net Profit Margin X Asset Turnover X Financial Leverage

$$= 9.2\% * 1.75 * 1.61$$

~ **25.9%**. Quite impressive I must say!

I understand this is a lengthy way to calculate RoE, but this is perhaps the best way as in the process of calculating RoE, we can develop valuable insights into the business. DuPont model not only answers what the return is but also the quality of the return.

However if you wish do a quick RoE calculation you can do so the following way:

RoE = Net Profits / Avg shareholders Equity

From the annual report we know for the FY14 the PAT is Rs.367 Crs

$$\text{RoE} = 367 / 1211$$

= **30.31%**

Return on Asset (RoA):

Having understood the DuPont Model, understanding the next two ratios should be simple. Return on Assets (RoA) evaluates the effectiveness of the entity's ability to use the assets to create profits. A well managed entity limits investments in non productive assets. Hence RoA indicates the management's efficiency at deploying its assets. Needless to say, higher the RoA, the better it is.

RoA = [Net income + interest*(1-tax rate)] / Total Average Assets

From the Annual Report, we know:

Net income for FY 14 = Rs.367.4 Crs

And we know from the Dupont Model the Total average assets (for FY13 and FY14) = Rs.1955 Crs

So what does **interest *(1- tax rate)** mean? Well, think about it, the loan taken by the company is also used to finance the assets which in turn is used to generate profits. So in a sense, the debtholders (entities who have given loan to the company) are also a part of the company. From this perspective the interest paid

out also belongs to a stakeholder of the company. Also, the company benefits in terms of paying lesser taxes when interest is paid out, this is called a 'tax shield'. For these reasons, we need to add interest (by accounting for the tax shield) while calculating the ROA.

The Interest amount (finance cost) is Rs.7 Crs, accounting for the tax shield it would be

$$= 7 * (1 - 32\%)$$

$$= 4.76 \text{ Crs} . \text{ Please note, } 32\% \text{ is the average tax rate.}$$

Hence ROA would be -

$$\text{RoA} = [367.4 + 4.76] / 1955$$

$$\sim 372.16 / 1955$$

$$\sim \mathbf{19.03\%}$$

Return on Capital Employed (ROCE):

The Return on Capital employed indicates the profitability of the company taking into consideration the overall capital it employs.

Overall capital includes both equity and debt (both long term and short term).

ROCE = [Profit before Interest & Taxes / Overall Capital Employed]

Overall Capital Employed = Short term Debt + Long term Debt + Equity

From ARBL's Annual Report we know:

Profit before Interest & Taxes = Rs.537.7 Crs

Overall Capital Employed:

Short term debt: Rs.8.3 Crs

Long term borrowing: Rs.75.9 Crs

Shareholders equity = Rs.1362 Crs

Overall capital employed: $8.3 + 75.9 + 1362 = 1446.2$ Crs

$$\text{ROCE} = 537.7 / 1446.2$$

$$= \mathbf{37.18\%}$$

Key takeaways from this chapter:

1. A Financial ratio is a useful financial metric of a company. On its own merit the ratio conveys very little information
2. It is best to study the ratio's recent trend or compare it with the company's peers to develop an opinion
3. Financial ratios can be categorized into 'Profitability', 'Leverage', 'Valuation', and 'Operating' ratios. Each of these categories give the analyst a certain view on the company's business
4. EBITDA is the amount of money the company makes after subtracting the operational expenses of the company from its operating revenue
5. EBITDA margin indicates the percentage profitability of the company at the operating level
6. PAT margin gives the overall profitability of the firm
7. Return on Equity (ROE) is a very valuable ratio. It indicates how much return the shareholders are making over their initial investment in the company
8. A high ROE and a high debt is not a great sign
9. DuPont Model helps in decomposing the ROE into different parts, with each part throwing light on different aspects of the business
10. DuPont method is probably the best way to calculate the ROE of a firm
11. Return on Assets is an indicator of how efficiently the company is utilizing its assets
12. Return on Capital employed indicates the overall return the company generates considering both the equity and debt.
13. For the ratios to be useful, it should be analyzed in comparison with other companies in the same industry.
14. Also, ratios should be analyzed both at a single point in time and as an indicator of broader trends over time

The Financial Ratio Analysis (Part 1)

9.1 – A note on Financial Ratios

Over the last few chapters we have understood how to read the financial statements. We will now focus our attention on analyzing these financial statements. The best way to analyze the financial statements is by studying the 'Financial Ratios'. The theory of financial ratios was made popular by Benjamin Graham, who is popularly known as the father of fundamental analysis. Financial ratios help in interpreting the results, and allows comparison with previous years and other companies in the same industry.

A typical financial ratio utilizes data from the financial statement to compute its value. Before we start understanding the financial ratios, we need to be aware of certain attributes of the financial ratios.

On its own merit, the financial ratio of a company conveys very little information. For instance, assume Ultratech Cements Limited has a profit margin of 15%, how useful do you think this information is? Well, not much really. 15% profit margin is good, but how would I know if it is the best?

However, assume you figure out ACC Cement's profit margin is 12%. Now, as we comparing two similar companies, comparing the profitability makes sense. Clearly, Ultratech Cements Limited seems to be a more profitable company between the two. The point that I am trying to drive across is that more often than not, Financial Ratios on its own is quite mute. The ratio makes sense only when you compare the ratio with another company of a similar size or when you look into the trend of the financial ratio. This means that once the ratio is computed the ratio has to be

analyzed (either by comparison or tracking the ratio's historical trend) to get the best possible inference.

Also, here is something that you need to be aware off while computing ratios. Accounting policies may vary across companies and across different financial years. A fundamental analyst should be cognizant of this fact and should adjust the data accordingly, before computing the financial ratio.

9.2 – The Financial Ratios

Financial ratios can be 'somewhat loosely' classified into different categories, namely

-

1. Profitability Ratios
2. Leverage Ratios
3. Valuation Ratios
4. Operating Ratios



The Profitability ratios help the analyst measure the profitability of the company. The ratios convey how well the company is able to perform in terms of generating profits. Profitability of a company also signals the competitiveness of the management. As the profits are needed for business expansion and to pay dividends to its shareholders a company's profitability is an important consideration for the shareholders.

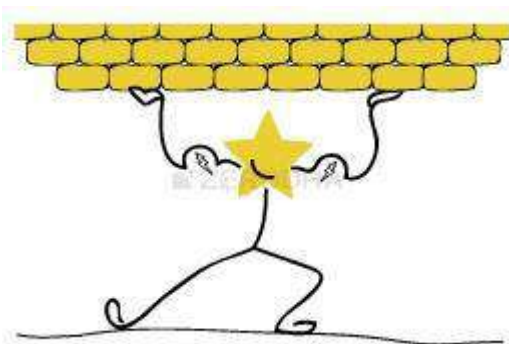

The Leverage ratios also referred to as solvency ratios/ gearing ratios measures the company's ability (in the long term) to sustain its day to day operations.

Leverage ratios measure the extent to which the company uses the debt to finance growth. Remember for the company to sustain its operations, it has to pay its bills and obligations. Solvency ratios help us understand the company's long term sustainability, keeping its obligation in perspective.



The Valuation ratios compare the stock price of the company with either the profitability of the company or the overall value of company to get a sense of how cheap or expensive the stock is trading. Thus this ratio helps us in analysing whether the current share price of the company is perceived as high or low. In simpler words, the valuation ratio compares the cost of a security with the perks of owning the stock.



The Operating Ratios, also called the 'Activity Ratios' measures the efficiency at which a business can convert its assets (both current and noncurrent) into revenues. This ratio helps us understand how efficient the management of the company is. For this reason, Operating Ratios are sometimes called the 'Management Ratios'.

Strictly speaking, ratios (irrespective of the category it belongs to) convey a certain message, usually related to the financial position of the company. For example, 'Profitability Ratio' can convey the efficiency of the company, which is usually measured by computing the 'Operating Ratio'. Because of such overlaps, it is difficult to classify these ratios. Hence the ratios are 'somewhat loosely' classified.

9.3 – The Profitability Ratios

We will look into the following ratios under 'The Profitability Ratio':

1. EBITDA Margin (Operating Profit Margin)
 - EBITDA Growth (CAGR)
2. PAT Margin
 - PAT Growth (CAGR)
3. Return on Equity (ROE)
4. Return on Asset (ROA)
5. Return on Capital Employed (ROCE)

EBITDA Margin:

The Earnings before Interest Tax Depreciation & Amortization (EBITDA)

Margin indicates the efficiency of the management. It tells us how efficient the company's operating model is. EBITDA Margin tells us how profitable (in percentage terms) the company is at an operating level. It always makes sense to compare the EBITDA margin of the company versus its competitor to get a sense of the management's efficiency in terms of managing their expense.

In order to calculate the EBITDA Margin, we first need to calculate the EBITDA itself.

$$\mathbf{EBITDA = [Operating Revenues - Operating Expense]}$$

$$\text{Operating Revenues} = [\text{Total Revenue} - \text{Other Income}]$$

$$\text{Operating Expense} = [\text{Total Expense} - \text{Finance Cost} - \text{Depreciation \& Amortization}]$$

$$\mathbf{EBITDA Margin = EBITDA / [Total Revenue - Other Income]}$$

Continuing the example of Amara Raja Batteries Limited, the EBITDA Margin calculation for the FY14 is as follows:

We first calculate EBITDA, which is computed as follows:

$$[\text{Total Revenue} - \text{Other Income}] - [\text{Total Expense} - \text{Finance Cost} - \text{Depreciation \& Amortization}]$$

Note: Other income is income by virtue of investments and other non operational activity. Including other income in EBITDA calculation would clearly skew the data. For this reason, we have to exclude Other Income from Total Revenues.

$$[3482 - 46] - [2942 - 0.7 - 65]$$

$$= [3436] - [2876]$$

$$\mathbf{= 560 Crores}$$

Hence the EBITDA Margin is:

$$560 / 3436$$

= 16.3%

I have two questions for you at this stage:

1. What does an EBITDA of Rs.560 Crs and an EBITDA margin of 16.3% indicate?
2. How good or bad an EBITDA margin of 16.3% is?

The first question is a fairly simple. An EBITDA of Rs.560 Crs means that the company has retained Rs.560 Crs from its operating revenue of Rs.3436 Crs. This also means out of Rs.3436 Crs the company spent Rs.2876 Crs towards its expenses. In percentage terms, the company spent 83.7% of its revenue towards its expenses and retained 16.3% of the revenue at the operating level, for its operations.

Now for the 2nd question, hopefully you should **not** have an answer.

Remember we did discuss this point earlier in this chapter. A financial ratio on its own conveys very little information. To make sense of it, we should either see the trend or compare it with its peers. Going with this, a 16.3% EBITDA margin conveys very little information.

To makes some sense of the EBITDA margin, let us look at Amara Raja's EBITDA margin trend for the last 4 years, (all numbers in Rs Crs, except EBITDA margin):

Year	Operating Revenues	Operating Expense	EBITDA	EBITDA Margin
2011	1761	1504	257	14.6%
2012	2364	2025	340	14.4%
2013	2959	2508	451	15.2%
2014	3437	2876	560	16.3%

It appears that ARBL has maintained its EBITDA at an average of 15%, and in fact on a closer look it is clear the EBITDA margin is increasing. This is a good sign as it shows consistency and efficiency in the management's operational capabilities.

In 2011 the EBITDA was Rs.257 Crs and in 2014 the EBITDA is Rs.560Crs. This translates to a 4 year **EBITDA CAGR growth** of 21%.

Please note, we have discussed the formula for CAGR in [module 1](#).

Clearly, it appears that both EBITDA margin and EBITDA growth are quite impressive. However we still do not know if it is the best. In order to find out if it is the best one needs to compare these numbers with its competitors. In case of ARBL it would be Exide batteries Limited. I would encourage you to do the same for Exide and compare the results.

PAT Margin:

While the EBITDA margin is calculated at the operating level, the Profit After Tax (PAT) margin is calculated at the final profitability level. At the operating level we consider only the operating expenses however there are other expenses such as depreciation and finance costs which are not considered. Along with these expenses there are tax expenses as well. When we calculate the PAT margin, all expenses are deducted from the Total Revenues of the company to identify the overall profitability of the company.

PAT Margin = [PAT/Total Revenues]

PAT is explicitly stated in the Annual Report. ARBL's PAT for the FY14 is Rs.367 Crs on the overall revenue of Rs.3482 Crs (including other income). This translates to a PAT margin of:

$$= 367 / 3482$$

$$=10.5 \%$$

Here is the PAT and PAT margin trend for ARBL:

Year	PAT (in INR Crs)	PAT Margin
2011	148	8.4%
2012	215	8.9%
2013	287	9.6%
2014	367	10.5%

The PAT and PAT margin trend seems impressive as we can clearly see a margin expansion. The 4 year CAGR growth stands at 25.48%, which is again good. Needless to say, it always makes sense to compare ratios with its competitors.

Return on Equity (RoE):

The Return on Equity (RoE) is a very important ratio, as it helps the investor assess the return the shareholder earns for every unit of capital invested. RoE measures the entity's ability to generate profits from the shareholders investments. In other words, RoE shows the efficiency of the company in terms of generating profits to its shareholders. Obviously, higher the RoE, the better it is for the shareholders. In fact this is one of the key ratios that helps the investor identify investable attributes of the company. To give you a perspective, the average RoE of top Indian companies vary between 14 – 16%. I personally prefer to invest in companies that have a RoE of 18% upwards.

This ratio is compared with the other companies in the same industry and is also observed over time.

Also note, if the RoE is high, it means a good amount of cash is being generated by the company, hence the need for external funds is less. Thus a higher ROE indicates a higher level of management performance.

RoE can be calculated as: [Net Profit / Shareholders Equity* 100]

There is no doubt that RoE is an important ratio to calculate, but like any other financial ratios it also has a few drawbacks. To help you understand its drawbacks, consider this hypothetical example.

Assume Vishal runs a Pizza store. To bake pizza's Vishal needs an oven which costs him Rs.10,000/-. Oven is an asset to Vishal's business. He procures the oven from his own funds and seeks no external debt. At this stage you would agree on his balance sheet he has a shareholder equity of Rs.10,000 and an asset equivalent to Rs.10,000.

Now, assume in his first year of operation, Vishal generates a profit of Rs.2500/-. What is his RoE? This is quite simple to compute:

$$\text{RoE} = 2500/10000*100$$

$$=25.0\%$$

Now let us twist the story a bit. Vishal has only Rs.8000/- he borrows Rs.2000 from his father to purchase an oven worth Rs.10000/-. How do you think his balance sheet would look?

On the liability side he would have:

Shareholder Equity = Rs.8000

Debt = Rs.2000

This makes Vishal's total liability Rs. 10,000. Balancing this on the asset side, he has an asset worth Rs.10,000. Let us see how his RoE looks now:

$$\text{RoE} = 2500 / 8000 * 100$$
$$= 31.25\%$$

With an additional debt, the RoE shot up quite significantly. Now, what if Vishal had only Rs.5000 and borrowed the additional Rs.5000 from his father to buy the oven. His balance sheet would look like this:

On the liability side he would have:

Shareholder Equity = Rs.5000

Debt = Rs.5000

Vishal's total liability is Rs. 10,000. Balancing this on the asset side, he has an asset worth Rs.10,000. Let us see how his RoE looks now:

$$\text{RoE} = 2500 / 5000 * 100$$
$$= 50.0\%$$

Clearly, higher the debt Vishal seeks to finance his asset, (which in turn is required to generate profits) higher is the RoE. A high RoE is great, but certainly not at the cost of high debt. The problem is with a high amount of debt, running the business gets very risky as the finance cost increases drastically. For this reason inspecting the RoE closely becomes extremely important. One way to do this is by implementing a technique called the **'DuPont Model' also called DuPont Identity**.

This model was developed in 1920's by the DuPont Corporation. DuPont Model breaks up the RoE formula into three components with each part representing a certain aspect of business. The DuPont analysis uses both the P&L statement and the Balance sheet for the computation.

The RoE as per DuPont model can be calculated as:

Return on Equity =	$\frac{\text{Net Profit}}{\text{Net Sales}}$	x	$\frac{\text{Net Sales}}{\text{Avg Total Assets}}$	x	$\frac{\text{Avg Total Assets}}{\text{Shareholder Equity}}$
---------------------------	--	---	--	---	---

If you notice the above formula, the denominator and the numerator cancels out with one another eventually leaving us with the original RoE formula which is:

$$\text{RoE} = \text{Net Profit} / \text{Shareholder Equity} * 100$$

However in the process of decomposing the RoE formula, we gained insights into three distinct aspects of the business. Let us look into the three components of the DuPont model that makes up the RoE formula :

- **Net Profit Margin = Net Profits/ Net Sales*100**
This is the first part of the DuPont Model and it expresses the company's ability to generate profits. This is nothing but the PAT margin we looked at earlier in this chapter. A low Net profit margin would indicate higher costs and increased competition.
- **Asset Turnover = Net Sales / Average Total asset**
Asset turnover ratio is an efficiency ratio that indicates how efficiently the company is using its assets to generate revenue. Higher the ratio, it means the company is using its assets more efficiently. Lower the ratio, it could indicate management or production problems. The resulting figure is expressed as number of times per year.
- **Financial Leverage = Average Total Assets / Shareholders Equity**
Financial leverage helps us answer this question – 'For every unit of shareholders equity, how many units of assets does the company have'. For example if the financial leverage is 4, this means for every Rs.1 of equity, the company supports Rs.4 worth of assets. Higher the financial leverage along with increased amounts of debt, will indicate the company is highly leveraged and hence the investor should exercise caution. The resulting figure is expressed as number of times per year.
As you can see, the DuPont model breaks up the RoE formula into three distinct components, with each component giving an insight into the company's operating and financial capabilities.

Let us now proceed to implement the DuPont Model to calculate Amara Raja's RoE for the FY 14. For this we need to calculate the values of the individual components.

Net Profit Margin: As I mentioned earlier, this is same as the PAT margin. From our calculation earlier, we know the Net Profit Margin for ARBL is **9.2%**

Asset Turnover = Net Sales / Average Total assets

We know from the FY14 Annual Report, Net sales of ARBL stands at Rs.3437 Crs.

The denominator has Average Total Assets which we know can be sourced from the Balance Sheet. But what does the word 'Average' indicate?

From ARBL's balance sheet, the total asset for FY14 is Rs.2139Crs. But think about this, the reported number is for the Financial Year 2014, which starts from 1st of April 2013 and close on 31st March 2014. This implies that at the start of the financial year 2014 (1st April 2013), the company must have commenced its operation with assets that it carried forward from the previous financial year (FY 2013). During the financial year (FY 2014) the company has acquired some more assets which when added to the previous year's (FY2013) assets totaled to Rs.2139 Crs. Clearly the company started the financial year with a certain rupee value of assets but closed the year with a totally different rupee value of assets.

Keeping this in perspective, if I were to calculate the asset turnover ratio, which asset value should I consider for the denominator? Should I consider the asset value at the beginning of the year or at the asset value at the end of the year? To avoid confusion, the practice is to take average of the asset values for the two financial years.

Do remember this technique of averaging line items, as we will be using this across other ratios as well.

From ARBL's annual report we know:

Net Sales in FY14 is Rs.3437Crs

Total Assets in FY13 is Rs.1770 Crs

Total Assets in FY14 is Rs.2139 Crs

Average Assets = $(1770 + 2139) / 2$

= 1955

Asset Turnover = $3437 / 1955$

= **1.75 times**

This means for every Rs.1 of asset deployed, the company is generating Rs.1.75 in revenues.

We will now calculate the last component that is the Financial Leverage.

Financial Leverage = Average Total Assets / Average Shareholders Equity

We know the average total assets is Rs.1955. We just need to look into the shareholders equity. For reasons similar to taking the "Average Assets" as opposed to just the current year assets, we will consider "Average Shareholder equity" as opposed to just the current year's shareholder equity.

Shareholders Equity for FY13 = Rs.1059 Crs

Shareholders Equity for FY14 = Rs.1362 Crs

Average shareholder equity = Rs.1211 Crs

Financial Leverage = $1955 / 1211$

= **1.61 times**

Considering ARBL has little debt, Financial Leverage of 1.61 is indeed an encouraging number. The number above indicates that for every Rs.1 of Equity, ARBL supports Rs.1.61 of assets.

We now have all the inputs to calculate RoE for ARBL, we will now proceed to do the same:

RoE = Net Profit Margin X Asset Turnover X Financial Leverage

= 9.2% * 1.75 * 1.61

~ **25.9%**. Quite impressive I must say!

I understand this is a lengthy way to calculate RoE, but this is perhaps the best way as in the process of calculating RoE, we can develop valuable insights into the business. DuPont model not only answers what the return is but also the quality of the return.

However if you wish do a quick RoE calculation you can do so the following way:

RoE = Net Profits / Avg shareholders Equity

From the annual report we know for the FY14 the PAT is Rs.367 Crs

RoE = 367 / 1211

= **30.31%**

Return on Asset (RoA):

Having understood the DuPont Model, understanding the next two ratios should be simple. Return on Assets (RoA) evaluates the effectiveness of the entity's ability to use the assets to create profits. A well managed entity limits investments in non productive assets. Hence RoA indicates the management's efficiency at deploying its assets. Needless to say, higher the RoA, the better it is.

RoA = [Net income + interest*(1-tax rate)] / Total Average Assets

From the Annual Report, we know:

Net income for FY 14 = Rs.367.4 Crs

And we know from the Dupont Model the Total average assets (for FY13 and FY14) = Rs.1955 Crs

So what does **interest *(1- tax rate)** mean? Well, think about it, the loan taken by the company is also used to finance the assets which in turn is used to generate profits. So in a sense, the debtholders (entities who have given loan to the company) are also a part of the company. From this perspective the interest paid

out also belongs to a stakeholder of the company. Also, the company benefits in terms of paying lesser taxes when interest is paid out, this is called a 'tax shield'. For these reasons, we need to add interest (by accounting for the tax shield) while calculating the ROA.

The Interest amount (finance cost) is Rs.7 Crs, accounting for the tax shield it would be

$$= 7 * (1 - 32\%)$$

= 4.76 Crs . Please note, 32% is the average tax rate.

Hence ROA would be -

$$\text{RoA} = [367.4 + 4.76] / 1955$$

$$\sim 372.16 / 1955$$

~19.03%

Return on Capital Employed (ROCE):

The Return on Capital employed indicates the profitability of the company taking into consideration the overall capital it employs.

Overall capital includes both equity and debt (both long term and short term).

ROCE = [Profit before Interest & Taxes / Overall Capital Employed]

Overall Capital Employed = Short term Debt + Long term Debt + Equity

From ARBL's Annual Report we know:

Profit before Interest & Taxes = Rs.537.7 Crs

Overall Capital Employed:

Short term debt: Rs.8.3 Crs

Long term borrowing: Rs.75.9 Crs

Shareholders equity = Rs.1362 Crs

Overall capital employed: $8.3 + 75.9 + 1362 = 1446.2$ Crs

$$\text{ROCE} = 537.7 / 1446.2$$

= 37.18%

Key takeaways from this chapter:

1. A Financial ratio is a useful financial metric of a company. On its own merit the ratio conveys very little information
2. It is best to study the ratio's recent trend or compare it with the company's peers to develop an opinion
3. Financial ratios can be categorized into 'Profitability', 'Leverage', 'Valuation', and 'Operating' ratios. Each of these categories give the analyst a certain view on the company's business
4. EBITDA is the amount of money the company makes after subtracting the operational expenses of the company from its operating revenue
5. EBITDA margin indicates the percentage profitability of the company at the operating level
6. PAT margin gives the overall profitability of the firm
7. Return on Equity (ROE) is a very valuable ratio. It indicates how much return the shareholders are making over their initial investment in the company
8. A high ROE and a high debt is not a great sign
9. DuPont Model helps in decomposing the ROE into different parts, with each part throwing light on different aspects of the business
10. DuPont method is probably the best way to calculate the ROE of a firm
11. Return on Assets is an indicator of how efficiently the company is utilizing its assets
12. Return on Capital employed indicates the overall return the company generates considering both the equity and debt.
13. For the ratios to be useful, it should be analyzed in comparison with other companies in the same industry.
14. Also, ratios should be analyzed both at a single point in time and as an indicator of broader trends over time

The Financial Ratio Analysis (Part 2)

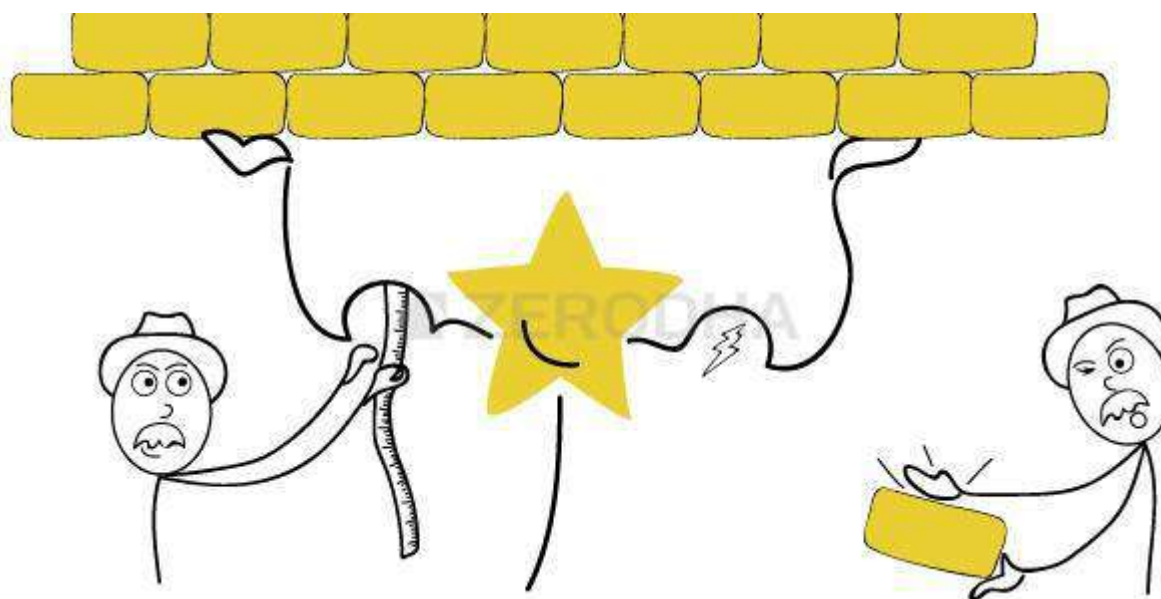

10.1 - The Leverage Ratios

We touched upon the topic of financial leverage while discussing Return on Equity and the DuPont analysis. The use of leverage (debt) is like a double edged sword.

Well managed companies seek debt if they foresee a situation where, they can deploy the debt funds in an environment which generates a higher return in contrast to the interest payments the company has to make to service its debt. Do recollect a judicious use of debt to finance assets also increases the return on equity.

However if a company takes on too much debt, then the interest paid to service the debt eats into the profit share of the shareholders. Hence there is a very thin line that separates the good and the bad debt. Leverage ratios mainly deal with the overall extent of the company's debt, and help us understand the company's financial leverage better.

We will be looking into the following leverage ratios:

1. Interest Coverage Ratio
2. Debt to Equity Ratio

3. Debt to Asset Ratio
4. Financial Leverage Ratio

So far we have been using Amara Raja Batteries Limited (ARBL) as an example, however to understand leverage ratios, we will look into a company that has a sizable debt on its balance sheet. I have chosen Jain Irrigation Systems Limited (JISL), I would encourage you calculate the ratios for a company of your choice.

Interest Coverage Ratio:

The interest coverage ratio is also referred to as debt service ratio or the debt service coverage ratio. The interest coverage ratio helps us understand how much the company is earning relative to the interest burden of the company. This ratio helps us interpret how easily a company can pay its interest payments. For example, if the company has an interest burden of Rs.100 versus an income of Rs.400, then we clearly know that the company has sufficient funds to service its debt. However a low interest coverage ratio could mean a higher debt burden and a greater possibility of bankruptcy or default.

The formula to calculate the interest coverage ratio:

[Earnings before Interest and Tax / Interest Payment]

The 'Earnings before Interest and Tax' (EBIT) is:

EBITDA – Depreciation & Amortization

Let us apply this ratio on Jain Irrigation Limited. Here is the snapshot of Jain Irrigation's P&L statement for the FY 14, I have highlighted the Finance costs in red:

CONSOLIDATED STATEMENT OF PROFIT AND LOSS FOR THE YEAR ENDED 31-MARCH-2014



		₹ in Million	
	Note No.	2013-2014	2012-2013
Revenue from operations	22	59,859.48	51,334.07
Less: Excise duty		(1,578.17)	(1,116.91)
Revenue from operations (net)		58,281.31	50,217.16
Other income	23	462.99	667.78
Total revenue		58,744.30	50,884.94
Expenses			
Cost of materials consumed	24	33,910.43	27,938.45
Changes in inventories of finished goods and work in progress	25	(501.88)	285.83
Employee benefit expenses	26	6,141.30	5,018.79
Finance costs	27	4,676.45	4,855.21
Depreciation and amortisation expense	13	2,045.40	1,695.59
Other expenses	28	11,404.66	9,921.82
Cost of self-generated capital equipment		(372.87)	(201.13)
Total expenses		57,303.49	49,514.56
Profit/(Loss) before exceptional and extraordinary items and tax		1,440.81	1,370.38
Exceptional items		2,300.37	1,245.09
Profit/(Loss) before tax		(859.56)	125.29
Tax expense			
- Current tax	29	233.03	175.08
- Deferred tax		(694.67)	(94.96)
Prior period expense		-	-
Profit/(Loss) for the year before minority interest		(397.92)	45.17
Share of loss in associate		-	(6.53)
Minority interest		(0.28)	(7.84)
Profit/(Loss) for the year		(398.20)	30.80
Earnings per share: (Face value ₹ 2 per share)	30		
Basic		(0.87)	0.07
Diluted		(0.87)	0.07

We know EBITDA = [Revenue – Expenses]

To calculate the expenses, we exclude the Finance cost (Rs.467.64Cr) and Depreciation & Amortization cost (Rs.204.54) from the total expenses of Rs.5730.34 Crs.

Therefore EBITDA = Rs.5828.13 – 5058.15 Crs

EBITDA = Rs. 769.98 Crs

We know EBIT = EBITDA – [Depreciation & Amortization]

= Rs.769.98 – 204.54

= Rs. 565.44

We know Finance Cost = Rs.467.64,

Hence Interest coverage is:

= 565.44/ 467.64

= **1.209x**

The 'x' in the above number represents a multiple. Hence 1.209x should be read as 1.209 'times'.

Interest coverage ratio of 1.209x suggests that for every Rupee of interest payment due, Jain Irrigation Limited is generating an EBIT of 1.209 times.

Debt to Equity Ratio:

This is a fairly straightforward ratio. Both the variables required for this computation can be found in the Balance Sheet. It measures the amount of the total debt capital with respect to the total equity capital. A value of 1 on this ratio indicates an equal amount of debt and equity capital. Higher debt to equity (more than 1) indicates higher leverage and hence one needs to be careful. Lower than 1 indicates a relatively bigger equity base with respect to the debt.

The formula to calculate Debt to Equity ratio is:

$$\text{[Total Debt/Total Equity]}$$

Please note, the total debt here includes both the short term debt and the long term debt.

Here is JSIL's Balance Sheet, I have highlighted total equity, long term, and short term debt:

CONSOLIDATED BALANCE SHEET AS AT 31-MARCH-2014				
	Note No.	31-Mar-2014	31-Mar-2013	₹ in Million
EQUITY AND LIABILITIES				
Shareholders' Funds				
Share capital	2	924.83	909.83	
Reserves and surplus	3	20,830.66	20,607.97	
Money received against share warrants	4	-	161.81	
		21,755.49	21,679.61	
Minority Interest		204.77	-	
Non-current liabilities				
Long term borrowings	5	14,976.63	14,329.38	
Deferred tax liabilities (net)	6	1,411.72	1,841.30	
Other long term liabilities	7	177.85	75.12	
Long term provisions	8	64.30	49.14	
		16,630.50	16,294.94	
Current liabilities				
Short term borrowings	9	21,869.15	19,840.56	
Trade payables	10	13,432.69	13,378.84	
Other current liabilities	11	7,579.49	6,522.43	
Short term provisions	12	552.38	491.46	
		43,453.71	40,233.29	
TOTAL		82,044.47	78,207.84	

Total debt = Long term borrowings + Short term borrowings

$$= 1497.663 + 2188.915$$

$$= \text{Rs.}3686.578\text{Cr}$$

Total Equity is Rs.2175.549 Crs

Thus, Debt to Equity ratio will be computed as follows:

$$= 3686.578 / 2175.549$$

$$= \mathbf{1.69}$$

Debt to Asset Ratio:

This ratio helps us understand the asset financing pattern of the company. It conveys to us how much of the total assets are financed through debt capital.

The formula to calculate the same is:

Total Debt / Total Assets

For JSIL, we know the total debt is Rs.3686.578Cr.

From the Balance Sheet, we know the total assets as Rs.8204.447 Crs:

ASSETS			
Non-current assets			
Fixed assets			
Goodwill on consolidation		2,192.12	1,759.49
Tangible assets	13[A]	25,003.91	23,772.59
Intangible assets	13[B]	575.41	554.00
Capital work-in-progress	13[C]	806.88	748.95
		28,578.32	26,835.03
Non-current investments	14	14.16	38.38
Deferred tax assets (net)	6	1,194.25	929.16
Long term loans and advances	15	3,260.87	2,264.10
Other non-current assets	16	1,050.66	1,694.75
Current assets			
Inventories	17	18,363.88	17,230.64
Trade receivables	18		17,994.04
Cash and bank balances	19		1,968.15
Short term loans and advances	20		5,557.59
Other current assets	21		4,062.55
		47,946.21	46,446.42
TOTAL		82,044.47	78,207.84

Hence the Debt to Asset ratio is:

$$= 3686.578 / 8204.44$$

$$= \mathbf{0.449 \text{ or } \sim 45\%}$$

This means roughly about 45% of the assets held by JSIL is financed through debt capital or creditors (and therefore 55% is financed by the owners). Needless to say, higher the percentage the more concerned the investor would be as it indicates higher leverage and risk.

Financial Leverage Ratio

We briefly looked at the financial leverage ratio in the previous chapter, when we discussed about Return on Equity. The financial leverage ratio gives us an indication, to what extent the assets are supported by equity.

The formula to calculate the Financial Leverage Ratio is:

Average Total Asset / Average Total Equity

From JSIL's FY14 balance sheet, I know the average total assets is Rs.8012.615. The average total equity is Rs.2171.755. Hence the financial leverage ratio or simply the leverage ratio is:

$$8012.615 / 2171.755$$

$$= \mathbf{3.68}$$

This means JSIL supports Rs.3.68 units of assets for every unit of equity. Do remember higher the number, higher is the company's leverage and the more careful the investor needs to be.

10.2 – Operating Ratios

Operating Ratios also called 'Activity ratios' or the 'Management ratios' indicate the efficiency of the company's operational activity. To some degree, the operating ratios reveal the management's efficiency as well. These ratios are called the Asset Management Ratios, as these ratios indicate the efficiency with which the assets of the company are utilized.

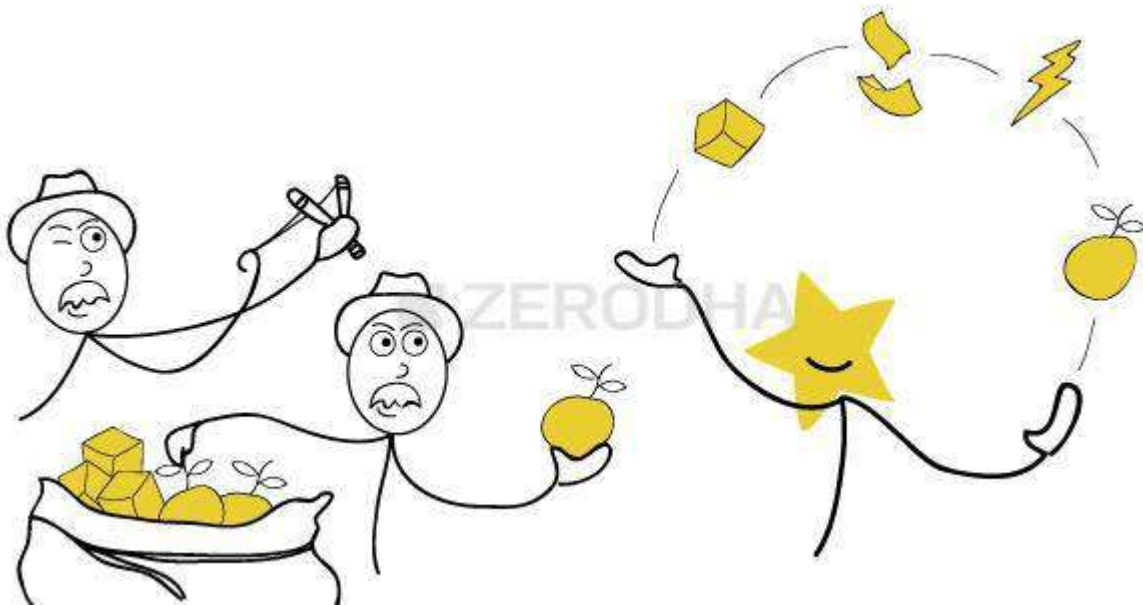

Some of the popular Operating Ratios are:

1. Fixed Assets Turnover Ratio
2. Working Capital Turnover Ratio
3. Total Assets Turnover Ratio
4. Inventory Turnover Ratio
5. Inventory Number of Days
6. Receivable Turnover Ratio
7. Days Sales Outstanding (DSO)

The above ratios combine data from both the P&L statement and Balance sheet. We will understand these ratios by calculating them for Amara Raja Batteries Limited.

To get a true sense of how good or bad the operating ratios of a company are, one must compare the ratios with the company's peers /competitors or these ratios should be compared over the years for the same company.

Fixed Assets Turnover

The ratio measures the extent of the revenue generated in comparison to its investment in fixed assets. It tells us how effectively the company uses its plant and equipment. Fixed assets include the property, plant and equipment. Higher the ratio, it means the company is effectively and efficiently managing its fixed assets.

Fixed Assets Turnover = Operating Revenues / Total Average Asset

The assets considered while calculating the fixed assets turnover should be net of accumulated depreciation, which is nothing but the net block of the company. It should also include the capital work in progress. Also, we take the average assets for reasons discussed in the previous chapter.

From ARBL's FY14 Balance Sheet:

ASSETS				
Non-current assets				
Fixed assets	10			
Tangible assets		6,198.94		3,554.97
Intangible assets		32.96		33.69
Capital work-in-progress		1,443.60		1,024.97
Intangible assets under development		3.14		4.84
		7,678.64		4,618.47

$$= (767.864 + 461.847)/2$$

$$= \text{Rs.}614.855 \text{ Crs}$$

We know the operating revenue for FY14 is Rs.3436.7 Crs, hence the Fixed Asset Turnover ratio is:

$$= 3436.7 / 614.85$$

$$= 5.59$$

While evaluating this ratio, do keep in mind the stage the company is in. For a very well established company, the company may not be utilizing its cash to invest in fixed assets. However for a growing company, the company may invest in fixed assets and hence the fixed assets value may increase year on year. You can notice this in case of ARBL as well, for the FY13 the Fixed assets value is at Rs.461.8 Crs and for the FY14 the fixed asset value is at Rs.767.8 Crs.

This ratio is mostly used by capital intensive industries to analyze how effectively the fixed assets of the company are used.

Working Capital Turnover

Working capital refers to the capital required by the firm to run its day to day operations. To run the day to day operations, the company needs certain type of assets. Typically such assets are – inventories, receivables, cash etc. If you realize these are current assets. A well managed company finances the current assets by current liabilities. The difference between the current assets and current liabilities gives us the working capital of the company.

Working Capital = Current Assets – Current Liabilities

If the working capital is a positive number, it implies that the company has **working capital surplus** and can easily manage its day to day operations. However if the working capital is negative, it means the company has a **working capital deficit**. Usually if the company has a working capital deficit, they seek a working capital loan from their bankers.

The concept of 'Working Capital Management' in itself is a huge topic in Corporate Finance. It includes inventory management, cash management, debtor's management etc. The company's CFO (Chief Financial Officer) strives to manage the company's working capital efficiently. Of course, we will not get into this topic as we will digress from our main topic.

The working capital turnover ratio is also referred to as Net sales to working capital. The working capital turnover indicates how much revenue the company generates for every unit of working capital. Suppose the ratio is 4, then it indicates that the company generates Rs.4 in revenue for every Rs.1 of working capital. Needless to say, higher the number, better it is. Also, do remember all ratios should be compared with its peers/competitors in the same industry and with the company's past and planned ratio to get a deeper insight of its performance.

The formula to calculate the Working Capital Turnover:

$$\text{Working Capital Turnover} = [\text{Revenue} / \text{Average Working Capital}]$$

Let us implement the same for Amara Raja Batteries Limited. To begin with, we need to calculate the working capital for the FY13 and the FY14 and then find out the average. Here is the snapshot of ARBL's Balance sheet, I have highlighted the current assets (red) and current liabilities (green) for both the years:

Current liabilities				
Short-term borrowings	7	83.83		98.63
Trade payables	8	1,277.79		1,362.84
Other current liabilities	9	2,156.68		1,807.26
Short-term provisions	6	2,818.73		2,493.20
			6,337.03	5,761.93
Total			21,394.41	17,704.70
ASSETS				
Non-current assets				
Fixed assets				
Fixed assets	10			
Tangible assets		6,198.94		3,554.97
Intangible assets		32.96		33.69
Capital work-in-progress		1,443.60		1,024.97
Intangible assets under development		3.14		4.84
		7,678.64		4,618.47
Non-current investments	11	160.76		160.76
Long-term loans and advances	12	567.69		353.52
Other non-current assets	13	1.22		3.43
			8,408.31	5,136.18
Current assets				
Inventories	14	3,350.08		2,928.58
Trade receivables	15	4,527.89		3,806.77
Cash and bank balances	16	2,945.67		4,107.90
Short-term loans and advances	12	2,119.30		1,656.78
Other current assets	13	43.16		68.49
			12,986.10	12,568.52

The average working capital for the two financial years can be calculated as follows:

Current Assets for the FY13	Rs.1256.85
Current Liabilities for the FY13	Rs.576.19
Working Capital for the FY13	Rs.680.66
Current Asset for the FY14	Rs.1298.61
Current Liability for the FY14	Rs.633.70
Working Capital for the FY14	Rs.664.91
Average Working Capital	Rs.672.78

We know the revenue from operations for ARBL is Rs.3437 Crs. Hence the working capital turnover ratio is:

$$= 3437 / 672.78$$

$$= \mathbf{5.11 \text{ times}}$$

The number indicates that for every Rs.1 of working capital, the company is generating Rs.5.11 in terms of revenue. Higher the working capital turnover ratio the better it is, as it indicates the company is generating better sales in comparison with the money it uses to fund the sales.

Total Assets Turnover

This is a very straight forward ratio. It indicates the company's capability to generate revenues with the given amount of assets. Here the assets include both the fixed assets as well as current assets. A higher total asset turnover ratio compared to its historical data and competitor data means the company is using its assets well to generate more sales.

$$\mathbf{\text{Total Asset Turnover} = \text{Operating Revenue} / \text{Average Total Assets}}$$

The average total assets for ARBL is as follows –

Total Assets for FY 13 – Rs.1770.5 Crs and Total Assets for FY 14 – 2139.4 Crs. Hence the average assets would be Rs. 1954.95 Crs.

Operating revenue (FY 14) is Rs. 3437 Crs. Hence Total Asset Turnover is:

= $3437 / 1954.95$

= **1.75 times**

Inventory Turnover Ratio

Inventory refers to the finished goods that a company maintains in its store or showroom with an expectation of selling the finished goods to prospective clients. Typically, the company besides keeping the goods in the store would also keep some additional units of finished goods in its warehouse.

If a company is selling popular products, then the goods in the inventory gets cleared rapidly, and the company has to replenish the inventory time and again. This is called the 'Inventory turnover'.

For example think about a bakery selling hot bread. If the bakery is popular, the baker probably knows how many pounds of bread he is likely to sell on any given day. For example, he could sell 200 pounds of bread daily. This means he has to maintain an inventory of 200 pounds of bread every day. So, in this case the rate of replenishing the inventory and the inventory turnover is quite high.

This may not be true for every business. For instance, think of a car manufacturer. Obviously selling cars is not as easy as selling bread. If the manufacturer produces 50 cars, he may have to wait for sometime before he sells these cars. Assume, to sell 50 cars (his inventory capacity) he will need 3 months. This means, every 3 months he turns over his inventory. Hence in a year he turns over his inventory 4 times.

Finally, if the product is really popular the inventory turnover would be high. This is exactly what the 'Inventory Turnover Ratio' indicates.

The formula to calculate the ratio is:

Inventory Turnover = [Cost of Goods Sold / Average Inventory]

Cost of goods sold is the cost involved in making the finished good. We can find this in the P&L Statement of the company. Let us implement this for ARBL.

To evaluate the cost of goods sold, I need to look into the expense of the company, here is the extract of the same:

EXPENSES			
Cost of materials consumed	19	21,011.95	17,603.12
Purchases of stock-in-trade	20	2,113.69	2,632.54
Changes in inventories of finished goods, work-in-process and stock-in-trade	20	(292.10)	(320.89)
Employee benefits expense	21	1,583.16	1,262.30
Finance costs	22	7.18	2.69
Depreciation and amortisation expense [includes impairment loss of ₹Nil (PY ₹75.52 million)]	23	645.71	660.92
Other expenses	24	4,346.60	3,904.24

Cost of materials consumed is Rs.2101.19 Crs and purchases of stock-in-trade is Rs.211.36 Crs. These line items are directly related to the cost of goods sold. Along with this I would also like to inspect 'Other Expenses' to identify any costs that are related to the cost of goods sold. Here is the extract of Note 24, which details 'Other Expenses'.

NOTE 24: OTHER EXPENSES		₹ million	
Particulars	Year ended March 31, 2014	Year ended March 31, 2013	
A. Manufacturing expenses			
a. Stores and spares consumed (including packing material)	449.41	378.41	
b. Power and fuel	922.56	978.14	
c. Insurance	8.49	7.29	
d. Repairs and maintenance to			
i) Machinery	44.46	55.79	
ii) Buildings	18.72	63.18	14.28
Total (A)	1,443.64	1,433.91	
B. Selling expenses			
a. Advertisement and promotion	275.85	154.41	
b. Freight outward	595.20	553.25	
c. Commission on sales	8.40	10.13	
d. Service expenses	219.36	94.16	
e. Warehousing and secondary freight	250.50	223.43	
f. Other sales expenses	242.15	155.81	
g. Royalty on sales	-	0.05	
h. Product warranties	383.15	494.62	
Total (B)	1,974.61	1,685.86	

There are two expenses that are directly related to manufacturing i.e. Stores & spares consumed which is at Rs.44.94 Crs and the Power & Fuel cost which is at Rs.92.25Crs.

Hence the Cost of Goods Sold = Cost of materials consumed + Purchase of stock in trade + Stores & spares consumed + Power & Fuel
= 2101.19 + 211.36 + 44.94 + 92.25
COGS= Rs.2449.74 Crs

This takes care of the numerator. For the denominator, we just take the average inventory for the FY13 and FY14. From the balance sheet – Inventory for the FY13 is Rs.292.85 Crs and for the FY14 is Rs.335.00 Crs. The average works out to Rs.313.92 Crs

The Inventory turnover ratio is:
= 2449.74 / 313.92

= 7.8 times
~ 8.0 times a year

This means Amara Raja Batteries Limited turns over its inventory 8 times in a year or once in every 1.5 months. Needless to say, to get a true sense of how good or bad this number is, one should compare it with its competitor's numbers.

Inventory Number of days

While the Inventory turnover ratio gives a sense of how many times the company 'replenishes' their inventory, the 'Inventory number of Days' gives a sense of how much time the company takes to convert its inventory into cash. Lesser the number of days, the better it is. A short inventory number of day's number implies, the company's products are fast moving. The formula to calculate the inventory number of days is:

Inventory Number of Days = 365 / Inventory Turnover

The inventory number of days is usually calculated on a yearly basis. Hence in the formula above, 365 indicates the number of days in a year.

Calculating this for ARBL:

= 365 / 7.8
= 46.79 days
~ 47.0 days

This means ARBL roughly takes about 47 days to convert its inventory into cash. Needless to say, the inventory number of days of a company should be compared with its competitors, to get a sense of how the company's products are moving.

Now here is something for you to think about – What would you think about the following situation?

1. A certain company under consideration has a high inventory turnover ratio
2. Because of a high inventory turnover ratio, the inventory number of days is very low
On the face of it, the inventory management of this company looks good. A high inventory turnover ratio signifies that the company is replenishing its inventory quickly, which is excellent. Along with the high inventory turnover, a low inventory number of days indicate that the company is quickly able to convert its goods into cash. Again, this is a sign of great inventory management.

However, what if the company has a great product (hence they are able to sell quickly) but a low production capacity? Even in this case the inventory turnover will be high and inventory days will be low. But a low production capacity can be a bit worrisome as it raises many questions about the company's production:

1. Why is the company not able to increase their production?

2. Are they not able to increase production because they are short of funds?
3. If they are short of funds, why can't they seek a bank loan?
4. Have they approached a bank and are not been able to raise a loan successfully?
5. If they are not able to raise a loan, why?
6. What if the management does not have a great track record, hence the banks hesitation to give a loan?
7. If funds are not a problem, why can't the company increase production?
8. Is sourcing raw materials difficult? Is the raw material required regulated by government (like Coal, power, Oil etc).
9. Difficult access to raw material – does that mean the business is not scalable?

As you can see, if any of the points above is true, then a red flag is raised, hence investing in the company may not be advisable. To fully understand the production issues (if any), the fundamental analyst should read through the annual report (especially the management discussion & analysis report) from the beginning to the end.

This means whenever you see impressive inventory numbers, always ensure to double check the production details as well.

Accounts Receivable Turnover Ratio

Having understood the inventory turnover ratio, understanding the receivable turnover ratio should be quite easy. The receivable turnover ratio indicates how many times in a given period the company receives money/cash from its debtors and customers. Naturally a high number indicates that the company collects cash more frequently.

The formula to calculate the same is:

Accounts Receivable Turnover Ratio = Revenue / Average Receivables

From the balance sheet we know,
 Trade Receivable for the FY13 : Rs.380.67 Crs
 Trade Receivable for the FY14 : Rs. 452.78 Crs
 Average Receivable for the FY13 : Rs.416.72
 Operating Revenue for the FY14 : Rs.3437 Crs

Hence the Receivable Turnover Ratio is:

= 3437 / 416.72
 = 8.24 times a year
 ~ 8.0 times

This means ARBL receives cash from its customers roughly about 8.24 times a year or once every month and a half.

Days Sales Outstanding (DSO) / Average Collection Period/ Day Sales in Receivables

The days sales outstanding ratio illustrates the average cash collection period i.e the time lag between billing and collection. This calculation shows the efficiency of the company's collection department. Quicker/faster the cash is collected from the creditors, faster the cash can be used for other activities. The formula to calculate the same is:

Days Sales outstanding = 365 / Receivable Turnover Ratio

Solving this for ARBL,
= 365 / 8.24
= 44.29 days

This means ARBL takes about 45 days from the time it raises an invoice to the time it can collect its money against the invoice.

Both Receivables Turnover and the DSO indicate the credit policy of the firm. A efficiently run company, should strike the right balance between the credit policy and the credit it extends to its customers.

Key takeaways from this chapter

1. Leverage ratios include Interest Coverage, Debt to Equity, Debt to Assets and the Financial Leverage ratios
2. The Leverage ratios mainly study the company's debt with respect to the company's ability to service the long term debt
3. Interest coverage ratio inspects the company's earnings ability (at the EBIT level) as a multiple of its finance costs
4. Debt to equity ratio measures the amount of equity capital with respect to the debt capital. Debt to equity of 1 implies equal amount of debt and equity
5. Debt to Asset ratio helps us understand the asset financing structure of the company (especially with respect to the debt)
6. The Financial Leverage ratio helps us understand the extent to which the assets are financed by the owner's equity
7. The Operating Ratios also referred to as the Activity ratios include – Fixed Assets Turnover, Working Capital turnover, Total Assets turnover, Inventory turnover, Inventory number of days, Receivable turnover and Day Sales Outstanding ratios
8. The Fixed asset turnover ratio measures the extent of the revenue generated in comparison to its investment in fixed assets

9. Working capital turnover ratio indicates how much revenue the company generates for every unit of working capital
10. Total assets turnover indicates the company's ability to generate revenues with the given amount of assets
11. Inventory turnover ratio indicates how many times the company replenishes its inventory during the year
12. Inventory number of days represents the number of days the company takes to convert its inventory to cash
 1. A high inventory turnover and therefore a low inventory number of days is a great combination
 2. However make sure this does not come at the cost of low production capacity
13. The Receivable turnover ratio indicates how many times in a given period the company receives money from its debtors and customers
14. The Days sales outstanding (DSO) ratio indicates the Average cash collection period i.e the time lag between the Billing and Collection

The Financial Ratio Analysis (Part 3)

11.1 – The Valuation Ratio

Valuation in general, is the estimate of the 'worth' of something. In the context of investments, 'something' refers to the price of a stock. When making an investment decision, irrespective of how attractive the business appears, what matters finally is the valuation of the business. Valuations dictate the price you pay to acquire a business. Sometimes, a mediocre business at a ridiculously cheap valuation may be a great investment option as opposed to an exciting business with an extremely high valuation.

The valuation ratios help us develop a sense on how the stock price is valued by the market participants. These ratios help us understand the attractiveness of the stock price from an investment perspective. The point of valuation ratios is to compare the price of a stock viz a viz the benefits of owning it. Like all the other ratios we had looked at, the valuation ratios of a company should be evaluated alongside the company's competitors.

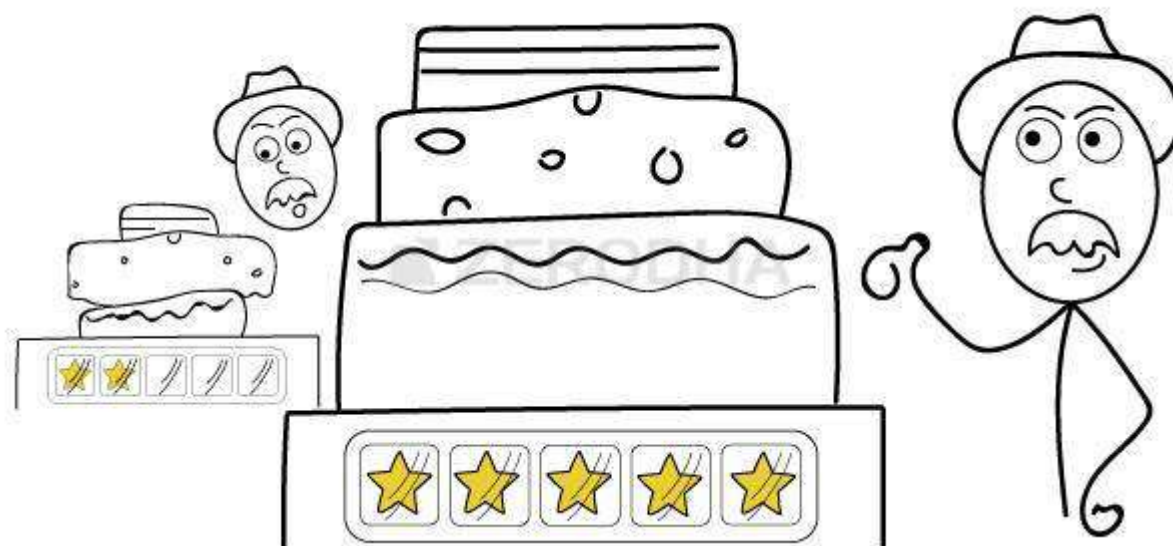

Valuation ratios are usually computed as a ratio of the company's share price to an aspect of its financial performance. We will be looking at the following three important valuation ratios:

1. Price to Sales (P/S) Ratio
2. Price to Book Value (P/BV) Ratio and

3. Price to Earnings (P/E) Ratio

Continuing with the Amara Raja Batteries Limited (ARBL) example, let us implement these ratios to see how ARBL fares. The stock price of ARBL is a vital input used to calculate the valuation ratios. As I write this chapter on 28th of Oct 2014, ARBL is trading at Rs.661 per share.

We also need the total number of shares outstanding in ARBL to calculate the above ratios. If you recollect, we have calculated the same in chapter 6. The total number of shares outstanding is 17,08,12,500 or 17.081Cr

Price to Sales (P/S) Ratio

In many cases, investors may use sales instead of earnings to value their investments. The earnings figure may not be true as some companies might be experiencing a cyclical low in their earning cycle. Additionally due to some accounting rules, a profitable company may seem to have no earnings at all, due to the huge write offs applicable to that industry. So, investors would prefer to use this ratio. This ratio compares the stock price of the company with the company's sales per share. The formula to calculate the P/S ratio is:

Price to sales ratio = Current Share Price / Sales per Share

Let us calculate the same for ARBL. We will take up the denominator first:

Sales per share = Total Revenues / Total number of shares

We know from ARBL's P&L statement the:

Total Revenue = Rs.3482 Crs

Number of Shares = 17.081 Crs

Sales per share = 3482 / 17.081

Therefore the Sales per share = Rs. 203.86

This means for every share outstanding, ARBL does Rs.203.86 worth of sales.

Price to Sales Ratio = 661 / 203.86

= 3.24x or 3.24 times

A P/S ratio of 3.24 times indicates that, for every Rs.1 of sales, the stock is valued Rs.3.24 times higher. Obviously, higher the P/S ratio, higher is the valuation of the firm. One has to compare the P/S ratio with its competitors in the industry to get a fair sense of how expensive or cheap the stock is.

Here is something that you need to remember while calculating the P/S ratio. Assume there are two companies (Company A and Company B) selling the same product. Both the companies generate a revenue of Rs.1000/-each. However, Company A retains Rs.250 as PAT and Company B retains Rs.150 as PAT. In this case, Company A has a profit margin of 25% versus Company B's which has a 15% profit margin. Hence the sales of Company A is more valuable than the sales of Company B. Hence if Company A is trading at a higher P/S, then the valuation maybe justified, simply because every rupee of sales Company A generates, a higher profit is retained.

Hence whenever you feel a particular company is trading at a higher valuation from the P/S ratio perspective, do remember to check the profit margin for cues.

Price to Book Value (P/BV) Ratio

Before we understand the Price to Book Value ratio, we need to understand what the term 'Book Value' means.

Consider a situation where the company has to close down its business and liquidate all its assets. What is the minimum value the company receives upon liquidation? The answer to this lies in the "Book Value" of the firm.

The "Book Value" of a firm is simply the amount of money left on table after the company pays off its obligations. Consider the book value as the salvage value of the company. Suppose the book value of a company is Rs.200Cr, then this is the amount of money the company can expect to receive after it sells everything and settles its debts. Usually the book value is expressed on a per share basis. For example, if the book value per share is Rs.60, then Rs.60 per share is what the shareholder can expect in case the company decides to liquidate. The 'Book Value' (BV) can be calculated as follows:

$BV = [\text{Share Capital} + \text{Reserves (excluding revaluation reserves)}] / \text{Total Number of shares}$

Let us calculate the same for ARBL:

From ARBL's balance sheet we know:

Share Capital = Rs.17.1 Crs

Reserves = Rs.1345.6 Crs

Revaluation Reserves = 0

Number of shares: 17.081

Hence the Book Value per share = $[17.1+1345.6 - 0] / 17.081$

= Rs.79.8 per share

This means if ARBL were to liquidate all its assets and pay off its debt, Rs.79.8 per shares is what the shareholders can expect.

Moving ahead, if we divide the current market price of the stock by the book value per share, we will get the price to the book value of the firm. The P/BV indicates how many times the stock is trading over and above the book value of the firm. Clearly the higher the ratio, the more expensive the stock is.

Let us calculate this for ARBL. We know:

Stock price of ARBL = Rs.661 per share

BV of ARBL = 79.8 per share

$P/BV = 661/79.8$

= 8.3x or 8.3 times

This means ARBL is trading over 8.3 times its book value.

A high ratio could indicate the firm is overvalued relative to the equity/ book value of the company. A low ratio could indicate the company is undervalued relative to the equity/ book value of the company.

Price to Earning (P/E) Ratio

The Price to Earnings ratio is perhaps the most popular financial ratio. Everybody likes to check the P/E of a stock. Because of the popularity the P/E ratio enjoys, it is often considered the 'financial ratio superstar'.

The P/E of a stock is calculated by dividing the **current stock price** by the **Earning Per share** (EPS). Before we proceed further to understand the PE ratio, let us understand what "Earnings per Share" (EPS) stands for.

EPS measures the profitability of a company on a per share basis. For example assume a certain company with 1000 shares outstanding generates a profit of Rs.200000/-. Then the earnings on a per share basis would be:

$= 200000 / 1000$

= Rs.200 per share.

Hence the EPS gives us a sense of the profits generated on a per share basis. Clearly, higher the EPS, better it is for its shareholders.

If you divide the current market price with EPS we get the Price to Earnings ratio of a firm. The P/E ratio measures the willingness of the market participants to pay for

the stock, for every rupee of profit that the company generates. For example if the P/E of a certain firm is 15, then it simply means that for every unit of profit the company earns, the market participants are willing to pay 15 times. Higher the P/E, more expensive is the stock.

Let us calculate the P/E for ARBL. We know from its annual report –

PAT = Rs.367Cr

Total Number of Shares = 17.081 Crs

EPS = PAT / Total Number of shares

= 367 / 17.081

= Rs.21.49

Current Market Price of ARBL = 661

Hence P/E = 661 / 21.49

= 30.76 times

This means for every unit of profit generated by ARBL, the market participants are willing to pay Rs.30.76 to acquire the share.

Now assume, ARBL's price jumps to Rs.750 while the EPS remains at Rs.21.49, the new P/E would be:

= 750/21.49

= 34.9 times

While the EPS stayed flat at Rs.21.49 per share, the stock's P/E jumped. Why do you think this happened?

Clearly, the P/E Ratio jumped because of the increase in the stock price. As we know the stock price of a company increases when the expectations from the company increases.

Remember, P/E Ratio is calculated with 'earnings' in its denominator. While looking at the P/E ratio, do remember the following key points:

1. P/E indicates how expensive or cheap the stock is trading at. Never buy stocks that are trading at high valuations. I personally do not like to buy stocks that are trading beyond 25 or at the most 30 times its earnings, irrespective of the company and the sector it belongs to
2. The denominator in P/E ratio is the 'Earnings', and the earnings can be manipulated

3. Make sure the company is not changing its accounting policy too often – this is one of the ways the company tries to manipulate its earnings.
4. Pay attention to the way depreciation is treated. Provision for lesser depreciation can boost earnings
5. If the company's earnings are increasing but not its cash flows and sales, then clearly something is not right

11.2 – The Index Valuation

Just like a stock, the stock market indices such as the BSE Sensex and the CNX Nifty 50 have their valuations which can be measured by the P/E, P/B and Dividend Yield ratios. The Index valuation is usually published by the stock exchanges on a daily basis. The index valuations give us a sense of how cheap or expensive the market is trading at. To calculate the CNX Nifty 50 P/E ratio, the National Stock Exchange combines the market capitalization for all the 50 stocks and divides that amount by the combined earnings for all the 50 stocks. Tracking the Index P/E ratio, gives a sense of the current state of market as perceived by the market participants. Here is the historical chart of Nifty 50 P/E ratio* –



* Source – Creytheon

From the P/E chart above, we can make a few important observations –

1. The peak Index valuation was 28x (early 2008), what followed this was a major crash in the Indian markets
 2. The corrections drove the valuation down to almost 11x (late 2008, early 2009). This was the lowest valuation the Indian market had witnessed in the recent past
 3. Usually the Indian Indices P/E ratio ranges between 16x to 20x, with an average of 18x
 4. As of today (2014) we are trading around 22x, which is above the average P/E ratio
- Based on these observations, the following conclusions can be made –

1. One has to be cautious while investing in stocks when the market's P/E valuations is above 22x
2. Historically the best time to invest in the markets is when the valuations are around 16x or below.

One can easily find out Index P/E valuation on a daily basis by visiting the [National Stock Exchange \(NSE\) website](#).

On NSE's home page click on Products > Indices > Historical Data > P/E, P/B & Div > Search

In the search field enter today's date and you will get the latest P/E valuation of the market. Do note, the NSE updates this information around 6:00 PM every day.

Here is a snapshot of the search result –

P/E, P/B & Div Yield values

Select the index you want:

Select Index:

Select a time period: To

P/E P/B Div Yield All

Historical CNX NIFTY P/E, P/B & Div. Yield values

For the period 13-11-2014 to 13-11-2014

Date	P/E	P/B	Div Yield
13-Nov-2014	21.26	3.53	1.27

Download file in csv format

Clearly as of today (13th Nov 2014) the Indian market is trading close to the higher end of the P/E range; history suggests that we need to be cautious while taking investment decisions at this level.

Key takeaways from this chapter

1. Valuation in general, is the estimate of the 'worth' of something
2. Valuation ratios involves inputs from both the P&L statement and the Balance Sheet
3. The Price to Sales ratio compares the stock price of the company with the company's sales per share
 - o Sales per share is simply the Sales divided by the Number of shares

4. Sales of a company with a higher profit margin is more valuable in comparison to the sales of a company with lower profit margins
5. If a company is going bankrupt, the 'Book Value' of a firm is simply the amount of money left on table after the company pays off its obligations
6. Book value is usually expressed on a per share basis
7. The Price/BV indicates how many times the stock price is trading over and above the book value of the firm
8. EPS measures the profitability of a company on a per share basis
9. The P/E ratio indicates the willingness of market participants to pay for a stock, keeping the company's earnings in perspective
10. One has to be cautious about the earning manipulation while evaluating the P/E ratio
11. The Indices have a valuation which can be measured by the P/E, P/B or Dividend Yield ratio
12. It is advisable to exercise caution when the Index is trading at a valuation of 22x or above
13. A valuation gets attractive when the index is trading at 16x or below
14. The index valuations are published by NSE on their website on a daily basis

The Investment Due Diligence

12.1 – Taking stock

Over the last few chapters we understood how to read the financial statements and calculate a few important financial ratios. These chapters have laid the foundation to the final objective of this module which is – To use fundamental analysis to identify the stocks to invest. If you recollect in the earlier chapters, we had discussed about investable grade attributes. Investable grade attributes simply define the prerequisites of a company that needs to be validated before making an investment decision. Think of the investable grade attributes as a checklist based on the fundamentals of the company. A company that satisfies most of the items in the checklist, is considered investment worthy.

Now this is where few differences come up. For instance, what I consider as an investable grade attribute may not be so important to you. For example – I may pay a lot of attention to corporate governance but another investor may choose not pay so much attention to corporate governance. He could simply brush it off saying “all companies have shades of grey, as long as the numbers add up I am fine investing in the company”.

So the point is, there is no prescribed checklist. Each investor has to build his own checklist based on his investment experience. However, one has to ensure that each item on the checklist is qualified based on sound logic. Later in this chapter, I will share a checklist that I think is reasonably well curated. You could take pointers from this checklist, if you are starting out fresh. We will keep this checklist as a guideline and proceed further in this module.

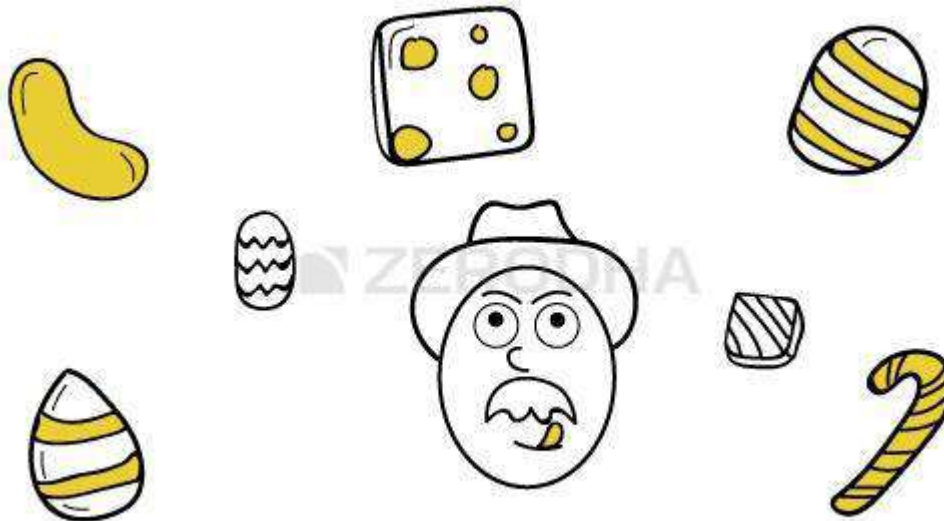

12.2 – Generating a stock idea

Now before we proceed further and generate a checklist, we must address a more basic issue. The process of investing requires us to first select a stock that looks interesting. After selecting the stock we must subject it to the checklist to figure out if the stock matches all the checklist criteria, if it does we invest, else we look for other opportunities.

So in the first place, how do we even select a stock that looks interesting? In other words, how do we generate a list of stocks that seems interesting enough to investigate further? Well, there are a few methods to do this –

1. **General Observation** – This may sound rudimentary, but believe me this is one of the best ways to develop a stock idea. All you need to do is keep your eyes and ears open and observe the economic activity around you. Observe what people are buying and selling, see what products are being consumed, keep an eye on the neighborhood to see what people are talking about. In fact Peter Lynch, one of the most illustrious Wall Street investor advocates this method in his book “One up on Wall Street”. Personally I have used this method to pick some of my investments – PVR Cinemas Ltd (because I noticed PVR multiplexes mushrooming in the City), Cummins India Limited (because I noticed most of the buildings had a Cummins diesel generator in their premises), and Info Edge Limited (Info Edge owns naukri.com, which is probably the most preferred job portal).
2. **Stock screener** – A stock screener helps to screen for stocks based on the parameters you define and therefore helps investors perform quality stock analysis .For example you can use a stock screener to identify stocks that have a ROE of 25% along with PAT margins of 20%. A stock screener is very helpful tool when you want to shortlist a handful of investment ideas from a big basket of stocks. There are

many stock screeners available; I personally like the Google finance's stock screener and screener.in.

3. **Macro Trends** – Keeping a general tab on the macroeconomic trend is a great way of identifying good stocks. Here is an illustration of the same – As of today there is a great push for infrastructure projects in India. An obvious beneficiary of this push would be the cement companies operating in India. Hence, I would look through all the cement companies and apply the checklist to identify which amongst all the cement companies are well positioned to leverage this macro trend.
4. **Sectoral Trends** – This is sector specific. One needs to track sectors to identify emerging trends and companies within the sector that can benefit from it. For example the non alcoholic beverages market is a very traditional sector. Mainly, three kinds of products are sold and they are coffee, tea, and packaged water. Hence, most of the companies manufacture and sell just these three products. However there is a slight shift in the consumer taste these days – the market for energy drink is opening up and it seems to be promising. Hence the investor may want to check for companies within the sector that is best positioned to leverage this change and adapt to it.
5. **Special Situation** – This is a slightly complicated way of generating a stock idea. One has to follow companies, company related news, company events etc to generate an idea based on special situation. One example that I distinctly remember was that of Cox & Kings. You may know that Cox & Kings is one of the largest and the oldest tour operator in India. In late 2013, the company announced inclusion of Mr.Keki Mistry (from HDFC Bank) to its advisory board. Corporate India has an immense respect for him as he is known to be a very transparent and efficient business professional. A colleague of mine was convinced that Cox & Kings would benefit significantly with Mr. Keki Mistry on its board. This alone acted as a primary trigger for my colleague to investigate the stock further. Upon further research my colleague happily invested in Cox & Kings Limited. Good for my him, as I write this today I know he is sitting on a 200% gain
6. **Circle of Competence** – This is where you leverage your professional skills to identify stock ideas. This is a highly recommended technique for a newbie investor. This method requires you to identify stocks within your professional domain. For example, if you are a medical professional your circle of competence would be the healthcare industry. You will probably be a better person to understand that industry than a stock broker or an equity research analyst. All you need to do is identify which are the listed companies in this space and pick the best based on your assessment. Likewise if you are banker, you will probably know more about banks than the others do. So, leverage your circle of competence to pick your investments.

The point is that the trigger for investigating stocks may come from any source. In fact, as and when you feel a particular stock looks interesting, just add it to your list. This list over time will be your 'watch list'. A very important thing to note here is that a stock may not satisfy the checklist items at a particular time, however as the time

progresses, as business dynamics change at some point it may match up to the checklist. Hence, it is important to evaluate the stocks in your watch list from time to time.

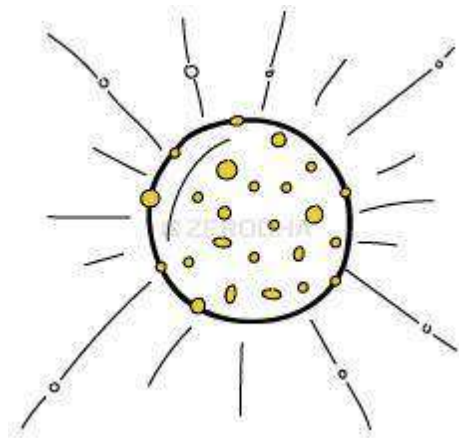

12.3 – The Moat

After selecting a stock, one has to run the checklist to investigate the stock further. This is called the “Investment due diligence”. The due diligence process is very critical and one has to ensure maximum attention is paid to each and every aspect of this exercise. I will shortly present a checklist that I think is reasonable. But before that, we need to talk about ‘The Moat’.

Moat (or economic moat) is a term that was popularized by Warren Buffet. The term simply refers to the company’s competitive advantage (over its competitors). A company with a strong moat, ensures the company’s long term profits are safeguarded. Of course the company should not only have a moat, but it should also be sustainable over a long period of time. A company which possesses wider moat characteristics (such as better brand name, pricing power, and better market share) would be more sustainable, and it would be difficult for the company’s rivals to eat away its market share.

To understand moats, think of “Eicher Motors Limited”. Eicher Motors is a major Indian automobile manufacturer. It manufactures commercial vehicles along with the iconic Royal Enfield bikes. The Royal Enfield bikes enjoy a huge fan following both in India and outside India. It has a massive brand recall. Royal Enfield caters to a niche segment which is growing fast. Their bikes are not as expensive as the Harley Davidson nor are they as inexpensive as probably the TVS bikes. It would be very hard for any company to enter this space and shake up or rattle the brand loyalty that Royal Enfield enjoys. In other words, displacing Eicher Motors from this sweet spot will require massive efforts from its competitors. This is one of Eicher Motors’ moat.

There are many companies that exhibit such interesting moats. In fact true wealth creating companies have a sustainable moat as an underlying factor. Think about

Infosys – the moat was labor arbitrage between US and India, Page Industries – the moat was manufacturing and distribution license of Jockey innerwear, Prestige Industries – the moat was manufacturing and selling pressure cookers, Gruh Finance Limited – the moat was small ticket size credits disbursed to a certain market segment...so on and so forth. Hence always invest in companies which have wider economic moats.

12.4 – The Due Diligence

The equity research due diligence process involves the following stages –

1. Understanding the business – requires reading the annual reports
2. Application of the checklist and
3. Valuation – to estimate the intrinsic value of the business

In **stage 1** i.e **Understanding the business** we dwell deep into the business with a perspective of knowing the company inside out. We need to make a list of questions for which we need to find answers to. A good way to start would be by posing a very basic question about the company – **What business is the company involved in?**

To find the answer, we do not go to Google and search, instead look for it in the company’s latest Annual Report or their website. This helps us understand what the company has to say about themselves.

When it comes to my own investing practice, I usually like to invest in companies where the competition is less and there is very little government intervention. For example, when I decided to invest in PVR Cinemas, there were only 3 listed players in that space. PVR, INOX, and Cinemax. PVR and Cinemax merged leaving just 2 listed companies in that space. However, there are a few new players who have entered this space now, hence it is time for me to re evaluate my investment thesis in PVR.

Once we are comfortable knowing the business, we move to **stage 2** i.e **application of the checklist**. At this stage we get some performance related answers. Without much ado, here is the 10 point checklist that I think is good enough for a start –

Sl No	Variable	Comment	What does it signify
1	Gross Profit Margin (GPM)	> 20%	Higher the margin, higher is the evidence of a sustainable moat

2	Revenue Growth	In line with the gross profit growth	Revenue growth should be in line with the profit growth
3	EPS	EPS should be consistent with the Net Profits	If a company is diluting its equity then it is not good for its shareholders
4	Debt Level	Company should not be highly leveraged	High debt means the company is operating on a high leverage. Plus the finance cost eats away the earnings
5	Inventory	Applicable for manufacturing companies	A growing inventory along with a growing PAT margin is a good sign. Always check the inventory number of days
6	Sales vs Receivables	Sales backed by receivables is not a great sign	This signifies that the company is just pushing its products to show revenue growth
7	Cash flow from operations	Has to be positive	If the company is not generating cash from operations then it indicates operating stress
8	Return on Equity	>25%	Higher the ROE, better it is for the investor, however make sure you check the debt levels along with this
9	Business Diversity	1 or 2 simple business lines	Avoid companies that have multiple business interests. Stick to companies that operate in 1 or 2 segments
10	Subsidiary	Not many	If there are too many subsidiaries then it could be a sign of the company siphoning off money. Be cautious while investing in such companies.

Lastly, a company could satisfy each and every point mentioned in the checklist above, but if the stock is not trading at the right price in the market, then there is no point buying the stock. So how do we know if the stock is trading at the right price or not? Well, this is what we do in **stage 3**. We need to run a **valuation exercise** on

the stock. The most popular valuation method is called the “**Discounted Cash Flow (DCF) Analysis**”.

Over the next few chapters, we will discuss the framework to go about formally researching the company. This is called “**Equity Research**”. The focus of our discussion on equity research will largely be on Stage 2 and 3, as I believe stage 1 involves reading up the annual report in a fairly detailed manner.

Key takeaways from this chapter

1. A stock idea can come from any source
 - Circle of competence and General observation is a great way to start
2. It is advisable to have a watch list which includes stocks that look interesting
3. Once a stock is identified we should look for sustainable moats
4. The due diligence process involves understanding the business, running the checklist to understand its financial performance, and the valuation exercise
5. When it comes to understanding the business, one should be completely thorough with the business operations of the company
6. The checklist should be improvised as and when the investor gains investment experience
7. The DCF method is one of the best techniques to identify the intrinsic value of the business

Equity Research (Part 1)

13.1 – What to expect?

Having set the context in the previous chapter, we will now proceed to develop a methodology for conducting a 'limited resource' equity research. The reason why I call it 'limited resource' is because you and I as a retail investor have access to just few resources to conduct equity research. These resources are – internet, company annual report, and MS Excel. Whilst an Institution has access to human resource (analyst), access to company management, financial data base (such as Bloomberg, Reuters, Factset etc), industry reports etc. So my objective here is to demonstrate how one can understand a company and its business better with the limited resources at hand. Of course we will do this exercise keeping the end objective in perspective i.e to make a decision on whether to buy or not to buy a stock.

As mentioned in the previous chapter, we will structure the equity research process in 3 stages-

1. Understanding the Business
2. Application of the checklist
3. Intrinsic Value estimation (Valuation) to understand the fair price of the stock

Each stage mentioned above has several steps within it. One must understand that there is no shortcut to this and one must not compromise any of these steps.

13.2 – Stock Price vs Business Fundamentals

When we take up a company for research, the first step is to understand the business as much as possible. People often miss this crucial step and go directly into the stock price analysis. Well, just analyzing the stock price is great if you have a short term perspective. However for long term investments, understanding the business is essential.

Why is it important you may wonder? Well, the reason is simple, the more you know the company the higher is your conviction to stay put with the investment especially during bad times (aka bear markets). Remember during bear markets, the prices react and not the business fundamentals. Understanding the company and its business well gives you the required conviction to reason out why it makes sense to stay invested in the stock even though the market may think otherwise. They say bear markets creates value, so if you have a high conviction on the company you should consider buying into the stock during bear markets and not really selling the

stock. Needless to say, this is highly counter intuitive and it takes years of investment practice to internalize this fact.

Anyway, moving ahead the best source to get information related to the business is the company's website and its annual report. We need to study at least the last 5 year annual report to understand how the company is evolving across business cycles.



13.3 - Understanding the Business

As a first step towards understanding the business, we need to make a list of questions for which we need to find answers to. Do note, the answers to all these questions can be found out by reading through the company's annual report and website.

Here are a bunch of questions that I think helps us in our quest to understand the business. I have discussed the rationale behind each question.

Sl No	Question	Rational behind the question
1	What does the company do?	To get a basic understanding of the business
2	Who are its promoters? What are their backgrounds?	To know the people behind the business. A sanity check to eliminate criminal background, intense political affiliation etc

3	What do they manufacture (in case it is a manufacturing company)?	To know their products better, helps us get a sense of the product's demand supply dynamics
4	How many plants do they have and where are they located?	To get a sense of their geographic presence. Also at times their plants could be located in a prime location, and the value of such location could go off balance sheet, making the company highly undervalued
5	Are they running the plant in full capacity?	Gives us an idea on their operational abilities, demand for their products, and their positioning for future demand
6	What kind of raw material is required?	Helps us understand the dependency of the company. For example the raw material could be regulated by Govt (like Coal) or the raw material needs to be imported either of which needs further investigation
7	Who are the company's clients or end users?	By knowing the client base we can get a sense of the sales cycle and efforts required to sell the company's products
8	Who are their competitors?	Helps in knowing the competitors. Too many competing companies means margin pressure. In such a case the company has to do something innovative. Margins are higher if the company operates in – monopoly, duopoly, or oligopoly market structure
9	Who are the major shareholders of the company?	Besides the promoter and promoter group, it helps to know who else owns the shares of the company. If a highly successful investor holds the shares in the company then it could be a good sign
10	Do they plan to launch any new products?	Gives a sense on how ambitious and innovative the company is. While at the same time a company launching products outside their domain raises some red flags – is the company losing focus?

11	Do they plan to expand to different countries?	Same rational as above
12	What is the revenue mix? Which product sells the most?	Helps us understand which segment (and therefore the product) is contributing the most to revenue. This in turns helps us understand the drivers for future revenue growth
13	Do they operate under a heavy regulatory environment?	This is both good and bad – Good because it acts a natural barrier from new competition to enter the market, bad because they are limited with choices when it comes to being innovative in the industry
14	Who are their bankers, auditors?	Good to know, and to rule out the possibility of the companies association with scandalous agencies
15	How many employees do they have? Does the company have labor issues?	Gives us a sense of how labor intensive the company's operations are. Also, if the company requires a lot of people with niche skill set then this could be another red flag
16	What are the entry barriers for new participants to enter the industry?	Helps us understand how easy or difficult it is for new companies to enter the market and eat away the margins
17	Is the company manufacturing products that can be easily replicated in a country with cheap labor?	If yes, the company maybe sitting on a time bomb – think about companies manufacturing computer hardware, mobile handsets, garments etc
18	Does the company have too many subsidiaries?	If yes, you need to question why? Is it a way for the company to siphon off funds?

These questions are thought starters for understanding any company. In the process of finding answers you will automatically start posting new questions for which you will have to find answers to. It does not matter which company you are looking at, if you follow this Q&A framework I'm very confident your understanding of the company would drastically increase. This is because the Q&A process

requires you to read and dig out so much information about the company that you will start getting a sense of greater understanding of the company.

Remember, this is the first step in the equity research process. If you find red flags (or something not right about the company) while discovering the answers, I would advise you to drop researching the company further irrespective of how attractive the business looks. In case of a red flag, there is no point proceeding to stage 2 of equity research.

From my experience I can tell you that stage 1 of equity research i.e 'Understanding the Company' takes about 15 hours. After going through this process, I usually try to summarize my thoughts on a single sheet of paper which would encapsulate all the important things that I have discovered about the company. This information sheet has to be crisp and to the point. If I'm unable to achieve this, then it is a clear indication that I do not know enough about the company. Only after going through stage 1, I proceed to stage 2 of equity research, which is "Application of Checklist". Please do bear in mind the equity research stages are sequential and should follow the same order.

We will now proceed to stage 2 of equity research. The best way to understand stage 2 is by actually implementing the checklist on a company.

We have worked with Amara Raja Batteries Limited (ARBL) throughout this module, hence I guess it makes sense to go ahead and evaluate the checklist on the same company. Do remember, the company may differ but the equity research framework remains the same.

As we proceed, a word of caution at this point – the discussion going forward will mainly revolve around ARBL as we will understand this company better. The idea here is not to showcase how good or bad ARBL is but instead to illustrate a framework of what I perceive as a 'fairly adequate' equity research process.

13.4 – Application of checklist

The stage 1 of equity research process helps us understand the how, what, who, and why of the business. It helps us develop a holistic view on the company. However, like they say – the proof of the pudding is in the eating; so no matter how attractive the business looks the numbers of the company should also look attractive.

The objective of the 2nd stage of equity research is to help us comprehend the numbers and actually evaluate if both the nature of the business and the financial performance of the business complement each other. If they do not complement each other then clearly the company will not qualify as investible grade.

We looked at the checklist in the previous chapter; I'll reproduce the same here for quick reference.

Sl No	Variable	Comment	What does it signify
1	Net Profit Growth	In line with the gross profit growth	Revenue growth should be in line with the profit growth
2	EPS	EPS should be consistent with the Net Profits	If a company is diluting its equity then it is not good for its shareholders
3	Gross Profit Margin (GPM)	> 20%	Higher the margin, higher is the evidence of a sustainable moat
4	Debt Level	Company should not be highly leveraged	High debt means the company is operating on a high leverage. Plus the finance cost eats away the earnings
5	Inventory	Applicable for manufacturing companies	A growing inventory along with a growing PAT margin is a good sign. Always check the inventory number of days
6	Sales vs Receivables	Sales backed by receivables is not a great sign	This signifies that the company is just pushing its products to show revenue growth
7	Cash flow from operations	Has to be positive	If the company is not generating cash from operations then it indicates operating stress
8	Return on Equity	>25%	Higher the ROE, better it is for the investor, however make sure you check the debt levels along with this

Let us go ahead and evaluate each of the checklist items on Amara Raja Batteries and see what the numbers are suggesting. To begin with we will look into the P&L items – Gross Profit, Net Profit, and EPS of the company.

Revenue & Pat Growth

The first sign of a company that may qualify as investable grade is the rate at which it is growing. To evaluate the growth the company, we need to check the revenue and PAT growth. We will evaluate growth from two perspectives –

1. Year on Year growth – this will give us a sense of progress the company makes on a yearly basis. Do note, industries do go through cyclical shifts. From that perspective if a company has a flat growth, it is ok. However just make sure you check the competition as well to ensure the growth is flat industry wide.
2. Compounded Annual Growth Rate (CAGR) – The CAGR gives us a sense of how the company is evolving and growing across business cycles. A good, investable grade company is usually the first company to overcome the shifts in business cycles. This will eventually reflect in a healthy CAGR.

Personally I prefer to invest in companies that are growing (Revenue and PAT) over and above 15% on a CAGR basis.

Let us see how ARBL fares here...

	FY 09 -10	FY 10-11	FY 11-12	FY 12 -13	FY 13 – 14
Revenue (INR Crs)	1481	1769	2392	3005	3482
Revenue Growth		19.4%	35.3%	25.6%	15.9%
PAT (INR Crs)	167	148	215	287	367
PAT Growth		(11.3%)	45.2%	33.3%	27.8%

The 5 year CAGR revenue growth is 18.6% and the 5 year CAGR PAT growth is 17.01%. These are an interesting set of numbers; they qualify as a healthy set of numbers. However, we still need to evaluate the other numbers on the checklist.

Earnings per Share (EPS)

The earnings per share represent the profitability on a per share basis. The EPS and PAT growing at a similar rate indicates that the company is not diluting the earnings by issuing new shares, which is good for the existing shareholders. One can think of this as a reflection of the company's management's capabilities.

FV Rs.1	FY 09 -10	FY 10-11	FY 11-12	FY 12 -13	FY 13 – 14
EPS (In INR)	19.56	17.34	12.59	16.78	21.51
Share Cap(INR Crs)	17.08	17.08	17.08	17.08	17.08
EPS Growth	–	-11.35%	– 27.39%	33.28%	28.18%

The 5 year EPS CAGR stands at 1.90% for the FY14.

Gross Profit margins

Gross profit margins, expressed as a percentage is calculated as a –

Gross Profits / Net Sales

Where,

Gross Profits = [Net Sales – Cost of Goods Sold]

Cost of goods sold is the cost involved in making the finished good, we had discussed this calculation while understanding the inventory turnover ratio. Let us proceed to check how ARBL's Gross Profit margins has evolved over the years.

In INR Crs, unless indicated	FY 09-10	FY 10-11	FY 11-12	FY 12 -13	FY 13 – 14
Net Sales	1464	1757	2359	2944	3404
COGS	1014	1266	1682	2159	2450
Gross Profits	450	491	677	785	954

Gross Profit Margins	30.7%	27.9%	28.7%	26.7%	28.0%
----------------------	-------	-------	-------	-------	-------

Clearly the Gross Profit Margins (GPM) looks very impressive. The checklist mandates a minimum GPM of 20%. ARBL has a much more than the minimum GPM requirement. This implies a couple of things –

1. ARBL enjoys a premium spot in the market structure. This maybe because of the absence of competition in the sector, which enables a few companies to enjoy higher margins
2. Good operational efficiency, which in turn is a reflection of management's capabilities

Debt level – Balance Sheet check

The first three points in the checklist were mainly related to the Profit & Loss statement of the company. We will now look through a few Balance sheet items. One of the most important line item that we need to look at on the Balance Sheet is the Debt. An increasingly high level of debt indicates a high degree of financial leverage. Growth at the cost of financial leverage is quite dangerous. Also do remember, a large debt on balance sheets means a large finance cost charge. This eats into the retained earnings of the firm.

Here is how the debt stands for ARBL –

Debt(INR Crs) Evaluation –

	FY 09-10	FY 10-11	FY 11-12	FY 12 -13	FY 13 – 14
Debt	91.19	95.04	84.07	87.17	84.28
EBIT	261	223	321	431	541
Debt/EBIT (%)	35%	42.61%	26.19%	20.22%	15.57%

The debt seems to have stabilized around 85Cr. In fact it is encouraging to see that the debt has come down in comparison to the FY 09-10. Besides checking for the interest coverage ratio (which we have discussed previously) I also like to check the debt as a percent of 'Earnings before interest and taxes' (EBIT). This just gives a quick perspective on how the company is managing its finance. We can see that the Debt/EBIT ratio has consistently reduced.

I personally think ARBL has done a good job here by managing its debt level efficiently.

Inventory Check

Checking for the inventory data makes sense only if the company under consideration is a manufacturing company. Scrutinizing the inventory data helps us in multiple ways –

1. Raising inventory with raising PAT indicates are signs of a growing company
2. A stable inventory number of days indicates management’s operational efficiency to some extent

Let us see how ARBL fares on the inventory data –

	FY 09-10	FY 10-11	FY 11-12	FY 12 -13	FY 13 – 14
Inventory (INR Crs)	217.6	284.7	266.6	292.9	335.0
Inventory Days	68	72	60	47	47
PAT (INR Crs)	167	148	215	287	367

The inventory number of days is more or less stable. In fact it does show some sign of a slight decline. Do note, we have discussed the calculation of the inventory number of days in the previous chapter. Both the inventory and PAT are showing a similar growth signs which is again a good sign.

Sales vs Receivables

We now look at the sales number in conjunction to the receivables of the company. A sale backed by receivables is not an encouraging sign. It signifies credit sales and therefore many questions arise out of it. For instance – are the company sales personal force selling products on credit? Is the company offering attractive (but not sustainable) credit to suppliers to push sales?

	FY 09-10	FY 10-11	FY 11-12	FY 12 -13	FY 13 – 14
Net Sales(INR Crs)	1464	1758	2360	2944	3403

Receivables (INR Crs)	242.3	305.7	319.7	380.7	452.6
Receivables as as a% of Net Sales	16.5%	17.4%	13.5%	12.9%	13.3%

The company has shown stability here. From the table above we can conclude a large part of their sales is not really backed back receivables, which is quite encouraging. In fact, just liked the inventory number of days, the receivables as % of net sales has also showed signs of a decline, which is quite impressive.

Cash flow from Operations

This is in fact one of the most important checks one needs to run before deciding to invest in a company. The company should generate cash flows from operations; this is in fact where the proof of the pudding lies. A company which is draining cash from operations raises some sort of red flag.

In INR Crs	FY 09-10	FY 10-11	FY 11-12	FY 12 -13	FY 13 – 14
Cash flow from Operations	214.2	86.1	298.4	335.4	278.7

The cash flow from operations though a bit volatile has remained positive throughout the last 5 years. This only means ARBL's core business operations are generating cash and therefore can be considered successful.

Return on Equity

We have discussed at length about Return on Equity in chapter 9 of this module. I would encourage you to go through it again if you wish to refresh. Return on Equity (ROE) measures in percentage the return generated by the company keeping the shareholders equity in perspective. In a sense ROE measures how successful the promoters of the company are for having invested their own funds in the company.

Here is how ARBL's ROE has fared for the last 5 years –

In INR Crs	FY 09-10	FY 10-11	FY 11-12	FY 12 -13	FY 13 – 14
PAT	167	148	215	287	367

Shareholders' Equity	543.6	645.7	823.5	1059.8	1362.7
ROE	30.7%	22.9%	26.1%	27.1%	27.0%

These numbers are very impressive. I personally like to invest in companies that have a ROE of over 20%. Do remember, in case of ARBL the debt is quite low, hence the good set of return on equity numbers is not backed by excessive financial leverage, which is again highly desirable.

Conclusion

Remember we are in stage 2 of equity research. I see ARBL qualifying quite well on almost all the required parameters in stage 2. Now, you as an equity research analyst have to view the output of stage 2 in conjunction with your finding from stage 1 (which deals with understanding the business). If you are able to develop a comfortable opinion (based on facts) after these 2 stages, then the business surely appears to have investable grade attributes and therefore worth investing.

However before you go out and buy the stock, you need to ensure the price is right. This is exactly what we do in stage 3 of equity research.

Key takeaways from this chapter

1. 'Limited Resource' Equity Research can be performed in 3 stages
 1. Understanding the Business
 2. Application of the checklist
 3. Valuations
2. The objective of the stage 1 i.e understanding the business requires us to gather all information related to the business. The best way to go about this is the Q&A way
3. In the Q&A way, we begin with posting some simple and straightforward questions for which we find answers
4. By the time we finish stage 1, we should be through with all the information related to the business
5. Most of the answers required in stage 1 is present in the company's annual report and website
6. Do remember while researching the company in stage 1, if there is something not very convincing about the company, it is often a good idea to stop researching further

7. It is very important for you get convinced (based on true facts) about the company in stage 1. This is how you will develop a strong conviction to stay put during bear markets
8. Stage 2 of Equity Research requires you to evaluate the performance of the company on various counts.
9. You will proceed to stage 3 only after the company clears in stage 1 & 2.

DCF Primer

14.1 – The Stock Price

In the previous chapter we understood stage 1 and stage 2 of equity research. Stage 1 dealt with understanding the business and stage 2 dealt with understanding the financial performance of the company. One can proceed to stage 3, only if he is convinced with the findings of both the earlier stages. Stage 3 deals with the stock price valuation.

An investment is considered a great investment only if a great business is bought at a great price. In fact, I would even stretch to say that it is perfectly fine to buy a mediocre business, as long as you are buying it at a great price. This only shows the significance of ‘the price’ when it comes to investing.

The objective of the next two chapters is to help you understand “the price”. The price of a stock can be estimated by a valuation technique. Valuation per say helps you determine the ‘intrinsic value’ of the company. We use a valuation technique called the “**Discounted Cash Flow (DCF)**” method to calculate the intrinsic value of the company. The intrinsic value as per the DCF method is the evaluation of the ‘perceived stock price’ of a company, keeping all the future cash flows in perspective.

The DCF model is made up of several concepts which are interwoven with one another. Naturally we need to understand each of these concepts individually and then place it in the context of DCF. In this chapter we will understand the core concept of DCF called “The Net Present Value (NPV)” and then we will proceed to understand the other concepts involved in DCF, before understanding the DCF as a whole.



14.2 - The future cash flow

The concept of future cash flow is the crux of the DCF model. We will understand this with the help of a simple example.

Assume Vishal is a pizza vendor who serves the best pizzas in town. His passion for baking pizzas leads him to an innovation. He invents an automatic pizza maker which automatically bakes pizzas. All he has to do is, pour the ingredients required for making a pizza in the slots provided and within 5 minutes a fresh pizza pops out. He figures out that with this machine, he can earn an annual revenue of Rs.500,000/- and the machine has a life span of 10 years.

His friend George is very impressed with Vishal's pizza machine. So much so that, George offers to buy this machine from Vishal.

Now here is a question for you - What do you think is the minimum price that George should pay Vishal to buy this machine? Well, obviously to answer this question we need to see how economically useful this machine is going to be for George. Assuming he buys this machine today (2014), over the next 10 years, the machine will earn him Rs.500,000/- each year.

Here is how George's cash flow in the future looks like -

2015	2016	2017	2018	2019	2020	2021	2022	2023	2024
500,000	500,000	500,000	500,000	500,000	500,000	500,000	500,000	500,000	500,000

Do note, for the sake of convenience, I have assumed the machine will start generating cash starting from 2015.

Clearly, George is going to earn Rs.50,00,000/- (10 x 500,000) over the next 10 years, after which the machine is worthless. One thing is clear at this stage, whatever is the cost of this machine, it cannot cost more than Rs.50,00,000/-. Think about it – Does it make sense to pay an entity a price which is more than the economic benefit it offers?

To go ahead with our calculation, assume Vishal asks George to pay “Rs.X” towards the machine. At this stage, assume George has two options – either pay Rs.X and buy the machine or invest the same Rs.X in a fixed deposit scheme which not only guarantees his capital but also pays him an interest of 8.5%. Let us assume that George decides to buy the machine instead of the fixed deposit alternative. This implies, George has foregone an opportunity to earn 8.5% risk free interest. This is the ‘opportunity cost’ for having decided to buy the machine.

So far, in our quest to price the automatic pizza maker we have deduced three crucial bits of information –

1. The total cash flow from the pizza maker over the next 10 years – Rs.50,00,000/-
2. Since the total cash flow is known, it also implies that the cost of the machine should be less than the total cash flow from the machine
3. The opportunity cost for buying the pizza machine is, an investment option that earns 8.5% interest

Keeping the above three points in perspective, let us move ahead. We will now focus on the cash flows. We know that George will earn Rs.500,000/- every year from the machine for the next 10 years. So think about this – George in 2014, is looking at the future –

1. How much is the Rs.500,000/- that he receives in 2016 worth in today's terms?
2. How much is the Rs.500,000/- that he receives in 2018 worth in today's terms?
3. How much is the Rs.500,000/- that he receives in 2020 worth in today's terms?
4. **To generalize, how much is the cash flow of the future worth in today's terms?**

The answer to these questions lies in the realms of the “**Time value of money**”. In simpler words, if I can calculate the value of all the future cash flows from that machine in terms of today's value, then I would be in a better situation to price that machine.

Please note – in the next section we will digress/move away from the pizza problem, but we will eventually get back to it.

14.3 – Time Value of Money (TMV)

Time value of money plays an extremely crucial role in finance. The TMV finds its application in almost all the financial concepts. Be it discounted cash flow analysis, financial derivatives pricing, project finance, calculation of annuities etc, the time value of money is applicable. Think of the 'Time value of money' as the engine of a car, with the car itself being the "Financial World".

The concept of time value of money revolves around the fact that, the value of money does not remain the same across time. Meaning, the value of Rs.100 today is not really Rs.100, 2 years from now. Inversely, the value of Rs.100, 2 years from now is not really Rs.100 as of today. Whenever there is passage of time, there is an element of opportunity. Money has to be accounted (adjusted) for that opportunity.

If we have to evaluate, what would be the value of money that we have today sometime in the future, then we need to move the 'money today' through the future. This is called the "**Future Value (FV)**" of the money. Likewise, if we have to evaluate the value of money that we are expected to receive in the future in today's terms, then we have to move the future money back to today's terms. This is called the "**Present Value (PV)**" of money.

In both the cases, as there is a passage of time, the money has to be adjusted for the opportunity cost. This adjustment is called "Compounding" when we have to calculate the future value of money. It is called "Discounting" when we have to calculate the present value of money.

Without getting into the mathematics involved (which by the way is really simple) I will give you the formula required to calculate the FV and PV.

Example 1 – How much is Rs.5000/- in today's terms (2014) worth five years later assuming an opportunity cost of 8.5%?

This is a case of Future Value (FV) computation, as we are trying to evaluate the future value of the money that we have today –

Future Value = Amount * (1+ opportunity cost rate) ^ Number of years.

$$= 5000 *(1 + 8.5%) ^ 5$$

$$= 7518.3$$

This means Rs.5000 today is comparable with Rs.7518.3 after 5 years, assuming an opportunity cost of 8.5%.

Example 2 – How much is Rs.10,000/- receivable after 6 years, worth in today's terms assuming an opportunity cost of 8.5%?

This is clearly the case of Present Value (PV) computation as we are trying to evaluate the present value of cash receivable in future in terms of today's value.

$$\text{Present Value} = \text{Amount} / (1 + \text{Discount Rate})^{\text{Number of years}}$$

$$= 10,000 / (1 + 8.5\%)^6$$

$$= 6129.5$$

This means Rs.10,000/- receivable after 6 years in future is comparable to Rs.6,129.5 in today's terms assuming a discount rate of 8.5%.

Example 3 – If I reframe the question in the first example – How much is Rs.7518.3 receivable in 5 years worth in today's terms given an opportunity cost @ 8.5%?

We know this requires us to calculate the present value. Also, since we have done the reverse of this in example 1, we know the answer should be Rs.5000/- . Let us calculate the present value to check this –

$$= 7518.3 / (1 + 8.5\%)^5$$

$$= 5000.0$$

Assuming you are clear with the concept of time value of money, I guess we are now equipped to go back to the pizza problem.

14.4 – The Net Present Value of cash flows

We are still in the process of evaluating the price of the pizza machine. We know George is entitled to receive a stream of cash flows (by virtue of owning the pizza machine) in the future. The cash flow structure is as follows

2015	2016	2017	2018	2019	2020	2021	2022	2023	2024
500,000	500,000	500,000	500,000	500,000	500,000	500,000	500,000	500,000	500,000

We posted this question earlier, let me repost it again – **How much is the cash flow of the future worth in today's terms?**

As we can see, the cash flow is uniformly spread across time. We need to calculate the present value of each cash flow (receivable in the future) by discounting it with the opportunity cost.

Here is a table that calculates the PV of each cash flow keeping the discount rate of 8.5% –

Year	Cash Flow (INR)	Receivable in (years)	Present Value (INR)
2015	500,000	1	460,829
2016	500,000	2	424,808
2017	500,000	3	391,481
2018	500,000	4	360,802
2019	500,000	5	332,535
2020	500,000	6	306,485
2021	500,000	7	282,470
2022	500,000	8	260,335
2023	500,000	9	239,946
2024	500,000	10	221,151
Total	50,00,000		32,80,842

The sum of all the present values of the future cash flow is called “**The Net Present Value (NPV)**”. The NPV in this case is Rs. **32,80,842**. This also means, the value of all the future cash flows from the pizza machine in today’s terms is Rs. **32,80,842**. So if George has to buy the pizza machine from Vishal, he has to ensure the price is Rs. **32,80,842** or lesser, but definitely not more than that and this is roughly how much the pizza machine should cost George.

Now, think about this – What if we replace the pizza machine with a company? Can we discount all future cash flows that the company earns with an intention to evaluate the company's stock price? Yes, we can and in fact this is exactly what will we do in the “Discounted Cash Flow” model.

Key takeaways from this chapter

1. A valuation model such as the DCF model helps us estimate the price of a stock
2. The DCF model is made up of several inter woven financial concepts
3. The ‘Time Value of Money’ is one of the most crucial concept in finance, as it finds its application in several financial concepts including the DCF method
4. The value of money cannot be treated the same across the time scale – which means the value of money in today's terms is not really the same at some point in the future
5. To compare money across time we have to ‘time travel the money’ after accounting for the opportunity cost
6. Future Value of money is the estimation of the value of money we have today at some point in the future
7. Present value of money is the estimation of the value of money receivable in the future in terms of today's value
8. The Net Present Value (NPV) of money is the sum of all the present values of the future cash flows

Equity Research (Part 2)

15.1 – Getting started with the DCF Analysis

We discussed about “The Net Present Value (NPV)” in the previous chapter. NPV plays a very important role in the DCF valuation model. Having understood this concept, we now need to understand a few other topics that are related to DCF valuation model. In fact, we will learn more about these concepts by implementing the DCF model on Amara Raja Batteries Limited (ARBL). With this, we will conclude the 3rd stage of Equity Research i.e ‘The Valuation’.

In the previous chapter in order to evaluate the price of the pizza machine, we looked at the future cash flows from the pizza machine and discounted them back to get the present value. We added all the present value of future cash flows to get the NPV. Towards the end of the previous chapter we also toyed around with the idea –What will happen if the pizza machine is replaced by the company’s stock? Well, in that case we just need an estimate of the future cash flows from the company and we will be in a position to price the company’s stock.

But what cash flow are we talking about? And how do we forecast the future cash flow for a company?



15.1 – The Free Cash Flow (FCF)

The cash flow that we need to consider for the DCF Analysis is called the “**Free Cash flow (FCF)**” of the company. The free cash flow is basically the excess operating cash that the company generates after accounting for capital expenditures such as buying land, building and equipment. This is the cash that shareholders enjoy after accounting for the capital expenditures. The mark of a healthy business eventually depends on how much free cash it can generate.

Thus, the free cash is the amount of cash the company is left with after it has paid all its expenses including investments.

When the company has free cash flows, it indicates the company is a healthy company. Hence investors often look out of such companies whose share prices are undervalued but who have high or rising free cash flow, as they believe over time the disparity will disappear as the share price will soon increase.

Thus the Free cash flow helps us know if the company has generated earnings in a year or not. Hence as an investor to assess the company's true financial health, look at the free cash flow besides the earnings.

FCF for any company can be calculated easily by looking at the cash flow statement. The formula is –

$$\text{FCF} = \text{Cash from Operating Activities} - \text{Capital Expenditures}$$

Let us calculate the FCF for the last 3 financial years for ARBL –

Particular	2011 -12	2012 -13	2013 -14
Cash from Operating Activities (after income tax)	Rs.296.28 Crs	Rs.335.46	Rs.278.7
Capital Expenditures	Rs.86.58	Rs.72.47	Rs.330.3
Free Cash Flow (FCF)	Rs.209.7	Rs.262.99	(Rs.51.6)

Here is the snapshot of ARBL's FY14 annual report from where you can calculate the free cash flow –

Particulars	Year ended March 31, 2014		Year ended March 31, 2013	
I. CASH FLOW FROM OPERATING ACTIVITIES				
Profit before tax from continuing operations		5,366.70		4,218.17
Add/(Less): Adjustments for				
a. Depreciation	636.69		577.20	
b. Amortization	11.04		8.20	
c. Impairment loss	-		75.52	
d. Net income on sale of tangible fixed assets	(2.26)		(0.04)	
e. Tangible fixed assets written off	24.90		44.27	
f. Donation of tangible fixed asset	0.03		-	
g. Interest paid on working capital facilities	0.03		0.11	
h. Provisions and credit balances written back	(3.90)		(6.44)	
i. Bad debts written off	31.33		4.84	
j. Provision for doubtful trade receivables and advances (net)	(30.50)		(38.69)	
k. Exchange gain on restatement - other than borrowings (net)	(33.81)		(13.18)	
l. Provision for leave encashment	14.83		33.43	
m. Provision for gratuity	6.75		6.74	
n. Provision for warranty	(40.22)		156.14	
o. Dividend received	(144.19)		(145.27)	
p. Interest received on bank and other deposits	(137.94)		(112.29)	
q. Interest on income tax	6.70		2.03	
r. Provision for wealth tax	2.00	342.48	1.83	596.40
Operating profit before working capital changes		5,798.18		4,814.57
Add/(Less): Adjustments for working capital changes				
a. Increase in inventories	(421.50)		(262.41)	
b. Increase in trade receivables	(711.71)		(571.57)	
c. Increase in loans and advances	(445.72)		(421.49)	
d. Increase/(decrease) in trade payables	(77.73)		490.32	
e. Increase in other current liabilities	341.23	(1,315.43)	671.36	(93.79)
Cash generated from operations		4,393.75		4,720.78
Less: a. Income tax	1,604.42		1,365.95	
b. Wealth tax	1.83	1,006.25	0.18	1,306.13
Net cash from operating activities - A		2,787.50		3,354.65
II. CASH FLOW FROM INVESTING ACTIVITIES				
a. Purchase of tangible fixed assets		(3,303.66)		(734.78)
b. Purchase of intangible fixed assets		(10.30)		(20.97)
c. Increase in capital work-in-progress		(423.26)		(718.50)
d. Decrease/(increase) in intangible assets under development		1.09		(0.25)
e. Sale of tangible fixed assets		4.98		1.80
g. Interest received on bank and other deposits		137.94		112.25

Please note, the Net cash from operating activities is computed after adjusting for income tax. The net cash from operating activities is highlighted in green, and the capital expenditure is highlighted in red.

You may now have a fair point in your mind – When the idea is to calculate the future free cash flow, why are we calculating the historical free cash flow? Well, the reason is simple, while working on the DCF model, we need to predict the future free cash flow. The best way to predict the future free cash flow is by estimating the historical average free cash flow and then sequentially growing the free cash flow by a certain rate.. This is a standard practice in the industry.

Now, by how much do we grow the free cash flow is the next big question? Well, the growth rate you would assume should be as conservative as possible. I personally like to estimate the FCF for at least 10 years. I do this by growing the cash flow at a certain rate for the first 5 years, and then I factor in a lower rate for the next five years. If you are getting a little confused here, I would encourage you to go through the following step by step calculation for a better clarity.

Step 1 – Estimate the average free cash flow

As the first step, I estimate the average cash flow for the last 3 years for ARBL –

$$= 209.7 + 262.99 + (51.6) / 3$$

=Rs.140.36 Crs

The reason for taking the average cash flow for the last 3 years is to ensure, we are averaging out extreme cash flows, and also accounting for the cyclical nature of the business. For example in case of ARBL, the latest year cash flow is negative at Rs.51.6 Crs. Clearly this is not a true representation of ARBL's cash flow, hence for this reason it is always advisable to take the average free cash flow figures.

Step 2 – Identify the growth rate

Select a rate which you think is reasonable. This is the rate at which, the average cash flow will grow going forward. I usually prefer to grow the FCF in 2 stages. The first stage deals with the first 5 years and the 2nd stage deals with the last 5 years. Specifically with reference to ARBL, I prefer to use 18% for the first 5 years and around 10% for the next five years. If the company under consideration is a mature company, that has grown to a certain size (as in a large cap company), I would prefer to use a growth rate of 15% and 10% respectively. The idea here is to be as conservative as possible.

Step 3 – Estimate the future cash flows

We know the average cash flow for 2013 -14 is Rs.140.26 Crs. At 18% growth, the cash flow for the year 2014 – 2015 is estimated to be –

$$= 140.36 * (1+18\%)$$

$$= \text{Rs. } 165.62 \text{ Crs.}$$

The free cash flow for the year 2015 – 2016 is estimated to be –

$$165.62 * (1 + 18\%)$$

$$= \text{Rs. } 195.43 \text{ Crs.}$$

So on and so forth. Here is a table that gives the detailed calculation...

Estimate of future cash flow –

Sl No	Year	Growth rate assumed	Future Cash flow (INR Crs)
01	2014 – 15	18%	165.62
02	2015 – 16	18%	195.43

03	2016 – 17	18%	230.61
04	2017 – 18	18%	272.12
05	2018 – 19	18%	321.10
06	2019 – 20	10%	353.21
07	2020 – 21	10%	388.53
08	2021 – 22	10%	427.38
09	2022 – 23	10%	470.11
10	2023 – 24	10%	517.12

With this, we now have a fair estimate of the future free cash flow. How reliable are these numbers you may ask. After all, predicting the free cash flow implies we are predicting the sales, expenses, business cycles, and literally every aspect of the business. Well, the estimate of the future cash flow is just that, it is an estimate. The trick here is to be as conservative as possible while assuming the free cash flow growth rate. We have assumed 18% and 10% growth rate for the future, these are fairly conservative growth rate numbers for a well managed and growing company.

15.2 – The Terminal Value

We have tried to predict the future free cash flow for upto 10 years. But what would happen to the company after the 10th year? Would it cease to exist? Well, it would not. A company is expected to be a 'going concern' which continues to exist forever. This also means as long as the company exists, there is some amount of free cash being generated. However as companies mature, the rate at which the free cash is generated starts to diminish.

The rate at which the free cash flow grows beyond 10 years (2024 onwards) is called the "**Terminal Growth Rate**". Usually the terminal growth rate is considered to be less than 5%. I personally like to set this rate between 3-4%, and never beyond that.

The **“Terminal Value”** is the sum of all the future free cash flow, beyond the 10th year, also called the terminal year. To calculate the terminal value we just have to take the cash flow of the 10th year and grow it at the terminal growth rate. However, the formula to do this is different as we are calculating the value literally to infinity.

Terminal Value = FCF * (1 + Terminal Growth Rate) / (Discount Rate - Terminal growth rate)

Do note, the FCF used in the terminal value calculation is that of the 10th year. Let us calculate the terminal value for ARBL considering a discount rate of 9% and terminal growth rate of 3.5% :

$$= 517.12 * (1 + 3.5\%) / (9\% - 3.5\%)$$

$$= \text{Rs.9731.25 Crs}$$

15.3 – The Net Present Value (NPV)

We know the future free cash flow for the next 10 years and we also know the terminal value (which is the future free cash flow of ARBL beyond the 10th year and upto infinity). We now need to find out the value of these cash flows in today's terms. As you may recall, this is the present value calculation. Once we find out the present value, we will add up these present values to estimate the net present value (NPV) of ARBL.

We will assume the discount rate at 9%.

For example in 2015 – 16 (2 years from now) ARBL is expected to receive Rs.195.29 Crs. At 9% discount rate the present value would be –

$$= 195.29 / (1+9\%)^2$$

$$= \text{Rs.164.37 Crs}$$

So here is how the present value of the future cash flows stack up –

Sl No	Year	Growth rate	Future Cash flow (INR Crs)	Present Value (INR Crs)
1	2014 – 15	18%	165.62	151.94
2	2015 – 16	18%	195.29	164.37

3	2016 – 17	18%	230.45	177.94
4	2017 – 18	18%	271.93	192.72
5	2018 – 19	18%	320.88	208.63
6	2019 – 20	10%	352.96	210.54
7	2020 – 21	10%	388.26	212.48
8	2021 – 22	10%	427.09	214.43
9	2022 – 23	10%	470.11	216.55
10	2023 – 24	10%	517.12	218.54
Net Present Value (NPV) of future free cash flows				Rs.1968.14 Crs

Along with this, we also need to calculate the net present value for the terminal value, to calculate this we simply discount the terminal value by discount rate –

$$= 9731.25 / (1+9\%)^{10}$$

$$= \text{Rs.}4110.69 \text{ Crs}$$

Therefore, the sum of the present values of the cash flows is = NPV of future free cash flows + PV of terminal value

$$= 1968.14 + 4110.69$$

$$= \text{Rs.}6078.83 \text{ Crs}$$

This means standing today and looking into the future, I expect ARBL to generate a total free cash flow of Rs.6078.83 Crs all of which would belong to the shareholders of ARBL.

15.4 – The Share Price

We are now at the very last step of the DCF analysis. We will now calculate the share price of ARBL based on the future free cash flow of the firm.

We now know the total free cash flow that ARBL is likely to generate. We also know the number of shares outstanding in the markets. Dividing the total free cash flow by the total number of shares would give us the per share price of ARBL.

However before doing that we need to calculate the value of 'Net Debt' from the company's balance sheet. Net debt is the current year total debt minus current year cash & cash balance.

Net Debt = Current Year Total Debt – Cash & Cash Balance

For ARBL this would be (based on FY14 Balance sheet) –

Net Debt = 75.94 – 294.5

= (Rs.218.6 Crs)

A negative sign indicates that the company has more cash than debt. This naturally has to be added to the total present value of free cash flows.

= Rs.6078.83 Crs – (Rs. 218.6 Crs)

= Rs.6297.43 Crs

Dividing the above number by the total number of shares should give us the share price of the company also called the intrinsic value of the company.

Share Price = Total Present Value of Free Cash flow / Total Number of shares

We know from ARBL's annual report the total number of outstanding shares is 17.081 Crs. Hence the intrinsic value or the per share value is –

= Rs.6297.43 Crs / 17.081 Crs

~ Rs.368 per share!

This in fact is the final output of the DCF model.

15.5 – Modeling Error & the intrinsic value band

The DCF model though quite scientific is built on a bunch of assumptions. Making assumptions, especially in finance takes on an art form. You get better at it, as you progress through and gain more experience. Hence for all practical purposes, it is advisable for us to assume (yet another assumption) that we have made a few

errors while making the intrinsic value calculation and hence we should accommodate for modeling errors.

A leeway for the modeling error simply allows us to be flexible with the calculation of the per share value. I personally prefer to add + 10% as an upper band and – 10% as the lower band for what I perceive as the intrinsic value of the stock.

Applying that on our calculation –

Lower intrinsic value = $368 * (1 - 10\%) = \text{Rs. } 331$

Upper intrinsic value = Rs.405

Hence, instead of assuming Rs.368 as the fair value of the stock, I would now assume that the stock is fairly valued between 331 and 405. This would be the intrinsic value band.

Now keeping this value in perspective, we check the market value of the stock. Based on its current market price we conclude the following –

1. If the stock price is below the lower intrinsic value band, then we consider the stock to be undervalued, hence one should look at buying the stock
2. If the stock price is within the intrinsic value band, then the stock is considered fairly valued. While no fresh buy is advisable, one can continue to hold on to the stock if not for adding more to the existing positions
3. If the stock price is above the higher intrinsic value band, the stock is considered overvalued. The investor can either book profits at these levels or continue to stay put. But should certainly not buy at these levels.

Keeping these guidelines, we could check for the stock price of Amara Raja Batteries Limited as of today (2nd Dec 2014). Here is a snapshot from the NSE's website –

Amara Raja Batteries Limited

Series: EQ |

Symbol: AMARAJABAT ISIN: INE885A01032 Status: Listed

Market Tracker

+ Securities Information

726.70	Pr. Close	Open	High	Low	Close
▼ -6.40 -0.87%	733.10	727.00	740.00	721.80	-

Trade Snapshot	Company Information	Peer Comparison	Historical Data
Print			
VWAP	729.79		
Face Value	1.00		
Traded Volume (shares)	2,40,940		
Traded Value (lacs)	1,758.36		
Free Float Market Cap(Crs)	6,003.00		
52 week high	794.00		
52 week low	315.50		
Lower Price Band	586.50		
Upper Price Band	879.70		

Order Book	Intra-day Chart	Stock V/s Index Chart	Quarterly Charts
Buy Qty.	Buy Price	Sell Price	Sell Qty.
21	726.55	726.75	45
10	726.35	726.80	285
35	726.10	727.00	65
50	726.05	727.25	25
187	726.00	727.30	90
21,403	Total Quantity		41,153

+ Security-wise Delivery Position (1DEC2014)

+ Value at Risk (VaR in %)

The stock is trading at Rs.726.70 per share! Way higher than the upper limit of the intrinsic value band. Clearly buying the stock at these levels implies one is buying at extremely high valuations.

15.6 –Spotting buying opportunities

Long term investment and activities surrounding long term investing is like a slow moving locomotive train. Active trading on the other hand is like the fast bullet train. When long term value opportunity is created, the opportunity lingers in the market for a while. It does not really disappear in a hurry. For instance, we now know that Amara Raja Batteries Limited is overvalued at current market price as it is trading way higher than the upper limit of the intrinsic value band. But the scene was totally different a year ago. Recall based on FY 2013- 2014, ARBL's intrinsic value band is between Rs. 331 and Rs.405.

Here is the chart of ARBL –



The blue highlight clearly shows that, the stock was comfortable trading within the band for almost 5 months! You could have bought the stock anytime during the year. After buying, all you had to do was stay put for the returns to roll!

In fact this is the reason why they say – Bear markets create value. The whole of last year (2013) the markets were bearish, creating valuable buying opportunities in quality stocks.

15.7 – Conclusion

Over the last 3 chapters, we have looked at different aspects of equity research. As you may have realized, equity research is simply the process of inspecting the company from three different perspectives (stages).

In stage 1, we looked at the qualitative aspects of the company. At this stage, we figured out who, what, when, how, and why of the company. I consider this as an extremely crucial stage of equity research. If something is not really convincing here, I do not proceed further. Remember markets are an ocean of opportunities, so do not force yourself to commit on to an opportunity that does not give you the right vibe.

I proceed to stage 2 only after I am 100% convinced with my findings in stage 1. Stage 2 is basically the application of the standard checklist, where we evaluate the performance of the company. The checklist that we have discussed is just my version, of what I think is a fairly good checklist. I would encourage you to build your own checklist, but make sure you have a reasonable logic while including each checklist item.

Assuming the company clears both stage 1 and 2 of equity research, I proceed to equity research stage 3. In stage 3, we evaluate the intrinsic value of the stock and

compare it with the market value. If the stock is trading cheaper than the intrinsic value, then the stock is considered a good buy. Else it is not.

When all the 3 stages align to your satisfaction, then you certainly would have the conviction to own the stock. Once you buy, stay put, ignore the daily volatility (that is in fact the virtue of capital markets) and let the markets take its own course.

Please note, I have included a DCF Model on ARBL, which I have built on excel. You could **download** this and use it as a calculator for other companies as well.

Key takeaways from this chapter

1. The free cash flow (FCF) for the company is calculated by deducting the capital expenditures from the net cash from operating activities
2. The free cash flow tracks the money left over for the investors
3. The latest year FCF is used to forecast the future year's cash flow
4. The growth rate at which the FCF is grown has to be conservative
5. Terminal growth rate is the rate at which the company's cash flow is supposed to grow beyond the terminal year
6. The terminal value is the value of the cash flow the company generates from the terminal year upto infinity
7. The future cash flow including the terminal value has to be discounted back to today's value
8. The sum of all the discounted cash flows (including the terminal value) is the total net present value of cash flows
9. From the total net present value of cash flows, the net debt has to be adjusted. Dividing this by the total number of shares gives us the per share value of the company
10. One needs to accommodate for modeling errors by including a 10% band around the share price
11. By including a 10% leeway we create an intrinsic value band
12. Stock trading below the range is considered a good buy, while the stock price above the intrinsic value band is considered expensive
13. Wealth is created by long term ownership of undervalued stocks
14. Thus, the DCF analysis helps the investors to identify whether the current share price of the company is justified or not.

The Finale



16.1 – The follies of DCF Analysis

In this concluding chapter, we will discuss a few important topics that could significantly impact the way you make your investment decisions. In the previous chapter, we learnt about the intrinsic value calculation using the Discounted Cash Flow (DCF) analysis. The DCF method is probably one of the most reliable methods available to evaluate the intrinsic value of a company's stock. However, the DCF method has its fair share of drawbacks which you need to be aware of. The DCF model is only as good as the assumptions which are fed to it. If the assumptions used are incorrect, the fair value and stock price computation could be skewed.

1. **DCF requires us to forecast** – To begin with, the DCF model requires us to predict the future cash flow and the business cycles. This is a challenge, let alone for a fundamental analyst but also for the top management of the company
2. **Highly sensitive to the Terminal Growth rate** – The DCF model is highly sensitive to the terminal growth rate. A small change in the terminal growth rate would lead to a large difference in the final output i.e. the per share value. For instance in the ARBL case, we have assumed 3.5% as the terminal growth rate. At 3.5%, the share price is Rs.368/- but if we change this to 4.0% (an increase of 50 basis points) the share price would change to Rs.394/-

3. **Constant Updates** – Once the model is built, the analyst needs to constantly modify and align the model with new data (quarterly and yearly data) that comes in. Both the inputs and the assumptions of the DCF model needs to be updated on a regular basis.
4. **Long term focus** – DCF is heavily focused on long term investing, and thus it does not offer anything to investors who have a short term focus. (i.e. 1 year investment horizon)

Also, the DCF model may make you miss out on unusual opportunities as the model are based on certain rigid parameters.

Having stated the above, the only way to overcome the drawbacks of the DCF Model is by being as conservative as possible while making the assumptions. Some guidelines for the conservative assumptions are –

1. **FCF (Free Cash Flow) growth rate** – The rate at which you grow the FCF year on year has to be around 20%. Companies can barely sustain growing their free cash flow beyond 20%. If a company is young and belongs to the high growth sector, then probably a little under 20% is justified, but no company deserves a FCF growth rate of over 20%
2. **Number of years** – This is a bit tricky, while longer the duration, the better it is. At the same time longer the duration, there would be more room for errors. I generally prefer to use a 10 year 2 stage DCF approach
3. **2 stage DCF valuation** – It is always a good practice to split the DCF analysis into 2 stages as demonstrated in the ARBL example in the previous chapter. As discussed ,In stage 1 I would grow the FCF at a certain rate, and in stage 2 I would grow the FCF at a rate lower than the one used in stage 1
4. **Terminal Growth Rate** – As I had mentioned earlier, the DCF model is highly sensitive to the terminal growth rate. Simple thumb rule here – keep it as low as possible. I personally prefer to keep it around 4% and never beyond it.

16.2 – Margin of Safety

Now, despite making some conservative assumptions things could still go wrong. How do you insulate yourself against that? This is where the concept of 'Margin of Safety' would arrive. The margin of safety thought process was popularized by Benjamin Graham in his seminal book titled "Intelligent Investor". The 'margin of safety' simply suggests that an investor should buy stocks only when it is available at a discount to the estimated intrinsic value calculation. Following the Margin of Safety does not imply successful investments, but would provide a buffer for errors in calculation.

Here is how I exercise the 'Margin of Safety' principle in my own investment practice. Consider the case of Amara Raja Batteries Limited; the intrinsic value estimate was around Rs.368/- per share. Further we applied a 10% modeling error to create the

intrinsic value band. The lower intrinsic value estimate was Rs.331/-. At Rs.331/- we are factoring in modeling errors. The Margin of Safety advocates us to further discount the intrinsic value. I usually like to discount the intrinsic value by another 30% at least.

But why should we discount it further? Aren't we being extra conservative you may ask? Well, yes, but this is the only way you can insulate yourself from the bad assumptions and bad luck. Think about it, given all the fundamentals, if a stock looks attractive at Rs.100, then at Rs.70, you can be certain it is indeed a good bet! This is in fact what the savvy value investors always practice.

Going back to the case of ARBL –

1. Intrinsic value is Rs.368/-
2. Accounting for modeling errors @10% the lower intrinsic band value is Rs.331/-
3. Discounting it further by another 30%, in order to accommodate for the margin of safety, the intrinsic value would be around Rs.230/-
4. At 230/- I would be a buyer in this stock with great conviction

Of course, when quality stocks falls way below its intrinsic value they get picked up by value investors. Hence when the margin of safety is at play, you should consider buying it as soon as you can. As a long term investor, sweet deals like this (as in a quality stock trading below its intrinsic value) should not be missed.

Also, remember good stocks will be available at great discounts mostly in a bear market, when people are extremely pessimistic about stocks. So make sure you have sufficient cash during bear markets to go shopping!

16.3 – When to sell?

Throughout the module we have discussed about buying stocks. But what about selling? When do we book profits? For instance assume you bought ARBL at around Rs.250 per share. It is now trading close to Rs.730/- per share. This translates to an absolute return of 192%. A great rate of return by any yardstick (considering the return is generated in over a year's time). So does that mean you actually sell out this stock and book a profit? Well the decision to sell depends on the disruption in investible grade attributes.

Disruption in investible grade attributes – Remember the decision to buy the stock does not stem from the price at which the stock trades. Meaning, we do not buy ARBL just because it has declined by 15%. We buy ARBL only because it qualifies through the rigor of the “investible grade attributes”. If a stock does not showcase investible grade attributes we do not buy. Therefore going by that logic, we hold on to stocks as long as the investible grade attributes stays intact.

The company can continue to showcase the same attributes for years together. The point is, as long as the attributes are intact, we stay invested in the stock. By virtue of these attributes the stock price naturally increases, thereby creating wealth for you. The moment these attributes shows signs of crumbling down, one can consider selling the stock.

16.4 – How many stocks in the portfolio?

The number of stocks that you need to own in your portfolio is often debated. While some say holding many stocks help you diversify risk, others say holding far fewer helps you take concentrated bets which can potentially reap great rewards. Here is what some of the legendary investors have advised when it comes to the number of stocks in your portfolio –

Seth Kalrman – 10 to 15 stocks

Warren Buffet – 5 to 10 stocks

Ben Graham – 10 to 30 stocks

John Keynes – 2 to 3 stocks

In my own personal portfolio, I have about 13 stocks and at no point I would be comfortable owning beyond 15 stocks. While it is hard to comment on what should be the minimum number of stocks, I do believe there is no point owning a large number of stocks in your portfolio. When I say large, I have a figure of over 20 in my mind.

16.5 – Final Conclusion

Over the last 16 chapters, we have learnt and discussed several topics related to the markets and fundamental analysis. Perhaps it is now the right time to wrap up and leave you with a few last points that I think are worth remembering –

1. **Be reasonable** – Markets are volatile; it is the nature of the beast. However if you have the patience to stay put, markets can reward you fairly well. When I say “reward you fairly well” I have a CAGR of about 15-18% in mind. I personally think this is a fairly decent and realistic expectation. Please don't be swayed by abnormal returns like 50- 100% in the short term, even if it is achievable it may not be sustainable
2. **Long term approach** – I have discussed this topic in chapter 2 as to why investors need to have a long term approach. Remember, money compounds faster the longer you stay invested
3. **Look for investible grade attributes** – Look for stocks that display investible grade attributes and stay invested in them as long as these attributes last. Book profits when you think the company no longer has these attributes

4. **Respect Qualitative Research** – Character is more important than numbers. Always look at investing in companies whose promoters exhibit good character
 5. **Cut the noise, apply the checklist** – No matter how much the analyst on TV/newspaper brags about a certain company don't fall prey to it. You have a checklist, just apply the same to see if it makes any sense
 6. **Respect the margin of safety** – As this literally works like a safety net against bad luck
 7. **IPO's** – Avoid buying into IPOs. IPOs are usually overpriced. However if you were compelled to buy into an IPO then analyze the IPO in the same 3 stage equity research methodology
 8. **Continued Learning** – Understanding markets requires a lifetime effort. Always look at learning new things and exploring your knowledge base.
- I would like to leave you with 4 book recommendations that I think will help you develop a great investment mindset.

1. [The Essays of Warren Buffet : Lessons for Investors & Managers](#)
2. [The Little Book that Beats the Market – By Joel Greenblatt](#)
3. [The Little Book of Valuations – By Aswath Damodaran](#)
4. [The Little Book that Builds Wealth – By Pat Dorsey](#)

So friends, with these points I would like to close this module on Fundamental Analysis. I hope you enjoyed reading this as much as I enjoyed writing it.

